

# SPICER<sup>®</sup> AXLE

## MAINTENANCE MANUAL

MODEL

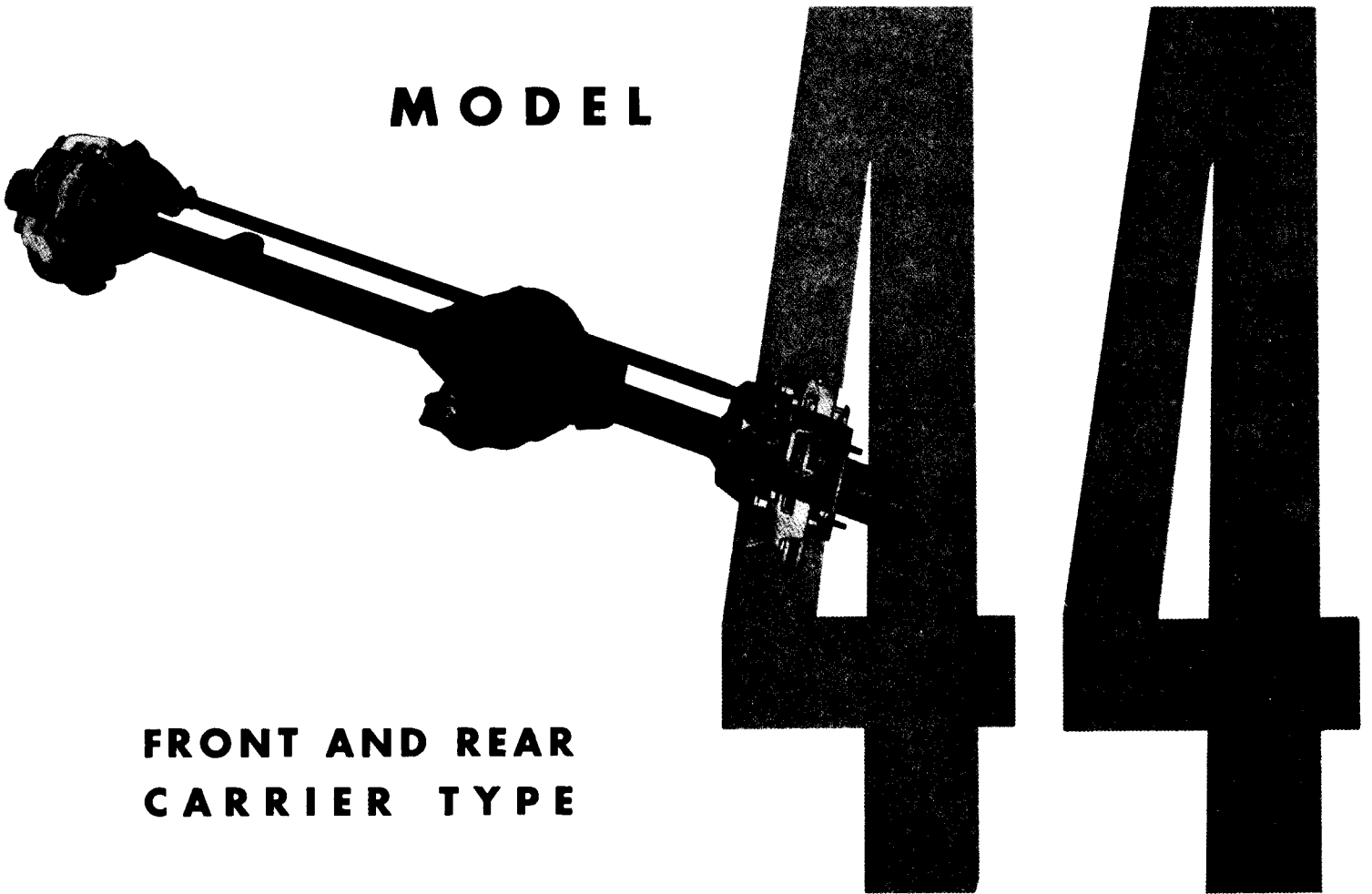

FRONT AND REAR  
CARRIER TYPE

---

SPICER AXLE DIVISION



DANA CORPORATION

FORT WAYNE, INDIANA

# INDEX

	<b>Page</b>
<b>LUBRICATION</b> -----	<b>3</b>
<b>IDENTIFICATION OF SERVICE TOOLS</b> -----	<b>4-5</b>
<b>AXLE IDENTIFICATION</b> -----	<b>5</b>
<b>FRONT AXLES – WHEEL ENDS</b>	
<b>40° Steer Ball Socket</b> -----	<b>6-19</b>
<b>Closed Knuckle Design</b> -----	<b>20-26</b>
<b>REAR AXLES – WHEEL ENDS</b>	
<b>Unit Wheel Bearing (Lubricated with Hypoid Gear Lube)</b> -----	<b>27-29</b>
<b>Unit Wheel Bearing (Lubricated with Grease)</b> -----	<b>29-32</b>
<b>Unit Wheel Bearing Removal and Installation</b> -----	<b>32-34</b>
<b>CARRIER SECTION</b> -----	<b>35-49</b>

## IMPORTANT SAFETY NOTICE

Should an axle assembly require component parts replacement, it is recommended that "Original Equipment" replacement parts be used. They may be obtained through your local service dealer or other original equipment manufacturer parts supplier. **CAUTION: THE USE OF NON-ORIGINAL EQUIPMENT REPLACEMENT PARTS IS NOT RECOMMENDED AS THEIR USE MAY CAUSE UNIT FAILURE AND/OR AFFECT VEHICLE SAFETY.**

Proper service and repair is important to the safe, reliable operation of all motor vehicles or driving axles whether they be front or rear. The service procedures recommended and described in this service manual are effective methods for performing service operations. Some of these service operations require the use of tools specially designed for the purpose. The special tool should be used when and as recommended.

It is impossible to know, evaluate and advise the service trade of all conceivable ways in which service might be done or of the possible hazardous consequences of each way.

Accordingly, anyone who uses a service procedure or tool which is not recommended must first satisfy himself thoroughly that neither his safety or vehicle safety will be jeopardized by the service methods he selects.

## NOTE

Throughout this manual, reference is made to certain tool numbers whenever special tools are required. These numbers are numbers of the Miller Special Tools, 32615 Park Lane, Garden City, Michigan 48135. They are used herein for customer convenience only. Dana Corporation makes no warranty or representation with respect to these tools.

# LUBRICATION

It is not our intent to recommend any particular brand or make of lubricant for Spicer axles. However, a S.A.E. 90 weight multipurpose gear lubricant meeting Mil. Spec. L-2105-B, or 80 W 90 multipurpose gear lubricant meeting Mil. Spec. L-2105-C, and suitable for A.P.I. Service Classification GL-5 is suggested as a minimum requirement.

## IMPORTANT

As special equipment limited slip differentials are provided in many vehicles, the freedom from "chatter" is a function of the lubricant used and cannot be covered in the above specifications. In some applications, a special limited slip differential lubricant may be required. If required, these special lubricants are normally available through the original equipment manufacturer.

## WHEEL BEARING LUBRICATION

Wheel bearings are lubricated by either grease packing the wheel bearing itself, or it can be lubricated from the hypoid gear lube in the housing.

For grease packing it is recommended that a number 2 consistency, lithium base 12 hydroxy stearate grease containing an E.P. additive be used. Such a lubricant would pass a load-carrying test at 40 pounds minimum with base oil pour point at  $-10^{\circ}$  F. maximum.

Wheel bearings which depend on lubrication from the hypoid gear lube in the axle housing, it is recommended that a S.A.E. 90 multipurpose gear lube meeting Mil. Spec. L-2105-B be used.

## CLOSED WHEEL END STEERING KNUCKLE LUBRICATION

The closed steering knuckle requires lubrication from a source other than the gear carrier assembly. Inboard tube seals contain the hypoid gear lube in the housing to provide an adequate lubricant level for the gears, bearings, etc. This then requires an additional lubricant level to be maintained outboard, in each steering knuckle, which can be observed by removing fill plugs on each knuckle. Adequate level would be to the bottom of the fill plug hole, when vehicle is observed to be in a normal horizontal position.

Recommended lubricant is a S.A.E. 140 grade, multipurpose gear lubricant meeting the Mil-L-2105-B specification.

## COLD WEATHER OPERATION

If the vehicle is operated below  $0^{\circ}$ F ( $-18^{\circ}$ C), it is advisable to use S.A.E. 80 multipurpose gear lubricant meeting Mil. Spec. L-2105-B and suitable for A.P.I. Service Classification GL-5.

## SUBMERSION OR DEEP WATER FORDING

If the vehicle is exposed to water deep enough to cover the hubs of either the front or rear axles, it is recommended that the wheel ends be disassembled and inspected for water damage, and/or contamination daily.

Clean, examine and replace damaged parts if necessary, prior to relubricating and assembling the wheel end components. Pay particular attention to the bearings and the closed steering knuckle on the front driving axle.

In the event the gear carrier housing should become submerged in water, particularly if over the breathers, it is recommended that the hypoid gear lubricant be drained daily and internal parts be inspected for water damage and/or contamination.

Clean, examine and replace damaged parts if necessary, prior to assembling the cover housing and refilling with the specified hypoid lubricant.

## NOTE

It is recommended that whenever bearings are removed they are to be replaced with new ones, regardless of mileage.

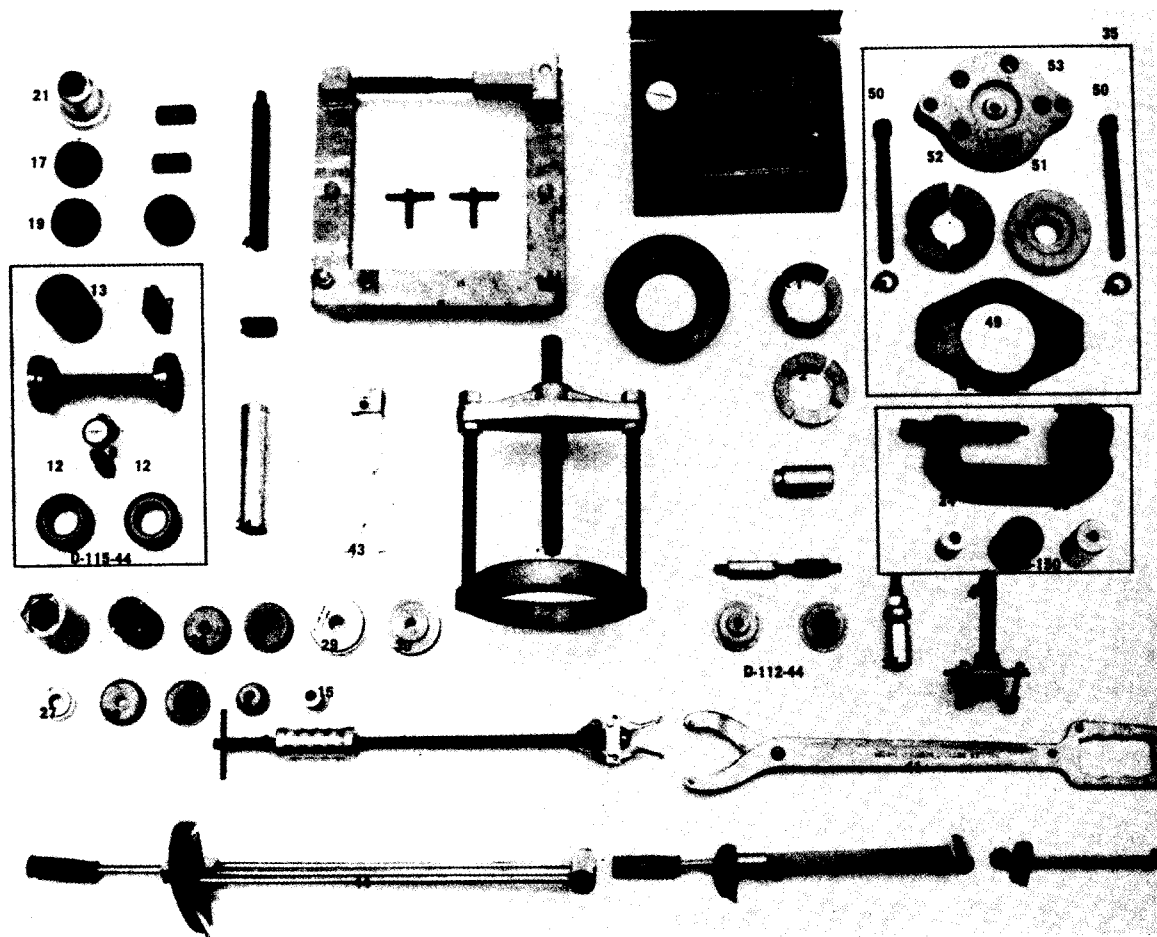

Figure 2

1009-2

The following is a detailed list of all Special Service Tools required to service the Model 44 Front and Rear Axles.

Item No.	Tool No.	Description	Item No.	Tool No.	Description
1	C-293-18	Adapter Set—Differential Bearing Cones	16	D-142	Installer—King Pin Bearing Cup (Heavy Duty)
2	C-293-39	Adapter Set—Rear Pinion Bearing Cone	17	D-144	Installer—Front Pinion Bearing Cup
**** 3	D-112	Screw	18	W-144A	Wrench—Wheel Bearing Adjusting (Nut Type)
**** 4	D-112-1	Installer—Front Axle—Differential Inner Oil Seal	19	D-145	Installer—Rear Pinion Bearing Cup
5	D-113	Spreader	20	D-147	Remover—Front Pinion Bearing Cup
* 6	D-115	Scooter Gauge	21	W-147-D	Installer—Pinion Oil Seal
* 7	D-115-1	Pinion Height Block	22	D-148	Remover—Rear Pinion Bearing Cup
* 8	D-115-3	Arbor	***23	D-150-1	Remover & Installer—Front Axle Ball Joint
* 9	D-115-4	Arbor Discs	***24	D-150-2	Adjuster—Ball Joint Removing
10	D-112	Installer—Front Spindle Needle Bearing	***25	D-150-3	Sleeve—Ball Joint Removing
11	D-131	Puller—Slide Hammer	***26	D-150-4	Sleeve—Ball Joint Installing
*12	D-135	Master Bearing Differential	27	D-151	Installer—King Pin Bearing Cup
*13	D-139	Master Pinion Block			
14	D-140	Installer—Front Brake Hub Cup (outer)			
15	D-141	Installer—Front Spindle Bushing			

Item No.	Tool No.	Description	Item No.	Tool No.	Description
28	D-153	Installer—Front Brake Hub Inner Bearing Cup (Regular)	43	C-4049	Remover—Bearing Cups
29	D-154	Installer—Front Brake Hub Inner Bearing Cup (Heavy Duty)	44	C-4053	Torque Wrench (300 ft. lb.)
30	D-155	Installer—Front Brake Hub Grease Seal (Reg. & Heavy Duty)	45	C-4169	Wrench—Upper Ball Joint Removing, Installing & Torquing
31	D-156	Installer—Differential Side Bearings	46	C-4170	Wrench—Wheel Bearing Adjusting (Lug Type)
32	D-157	Installer—Axle Shaft Outer Oil Seal	47	C-4171	Handle—Universal
33	W-162	Installer—Flange or Yoke	**48	SP-3020	Washers
34	W-262	Installer—Rear Pinion Bearing Cone	**49	SP-5017	Adapter Ring
**35	W-343-44D	Remover & Installer—Axle Shaft Bearings	**50	SP-5026	Bolts
36	C-452	Remover—Flange or Yoke	**51	SP-5439	Adapter Plate—Installer
37	C-524-A	Torque Wrench (100 ft. lb.)	**52	SP-5442-D	Adapter Set—Removing
38	C-685-A	Torque Wrench (300 inch lb.)	**53	SP-5443-A	Flange Plate
39	DD-914-P	Press	54	D-128	Dial Indicator Set
40	DD-914-9	Adapter Ring			
41	C-3281	Holder—Flange or Yoke			
42	C-293-3	Adapter Plug—Differential Hub			

\*Pinion Setting Gauge and Master Differential Bearing Kit D-115-44  
\*\*Axle Shaft Bearing Removing and Installing Kit W-343-44D  
\*\*\*40 Degree Steer Front Ball Joint Removing and Installing Kit D-150  
\*\*\*\*Inner Axle Shaft Seal Installing Kit D-112-44

**Note:** Torque wrenches C-524A, C-685-A, and C-4053 are optional and can be purchased separately. These Torque wrenches are not included in the DW-44 Axle Tool Kit.

## AXLE IDENTIFICATION

All Spicer axles are identified with a manufacturing date and the complete part number stamped in the right hand tube. Also each axle contains a gear ratio tag; and if the axle is equipped with a limited slip differential, it will contain a tag requesting the use of limited slip lubricant.

In the figure the axle is identified with 1/8" high numbers stamped in the tube. For example, the numbers 10-10-2 A5 is the manufacturing or build date of the axle and is interpreted as follows. The first number is the month, the second number is the day of the month, the third number is the year, the letter is the shift and the last number is the line that built the axle. For example: October 10, 1972, first shift, line 5.

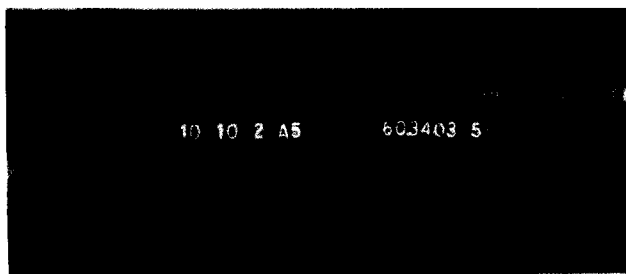

Figure 3

1009-3

### NOTE

In the event there are two build dates, the latter will be the date in which the brake components were assembled.

It is recommended that when referring to the axle, obtain the complete part number and build date. To do this, it may be necessary to wipe or scrape off the dirt, etc., from the tube.

### NOTE

On front driving axles, the above numbers can be either on the long or short tube.

# AXLE IDENTIFICATION

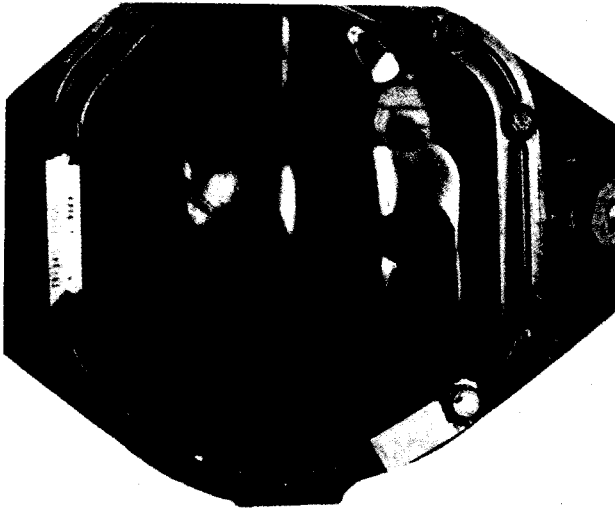

Figure 4

1009-4

The gear ratio tag is located on the left side of the cover plate and is held in place with two cover plate screws. This tag gives the tooth combination of the ring and pinion, the total gear ratio, and also the customer part number.

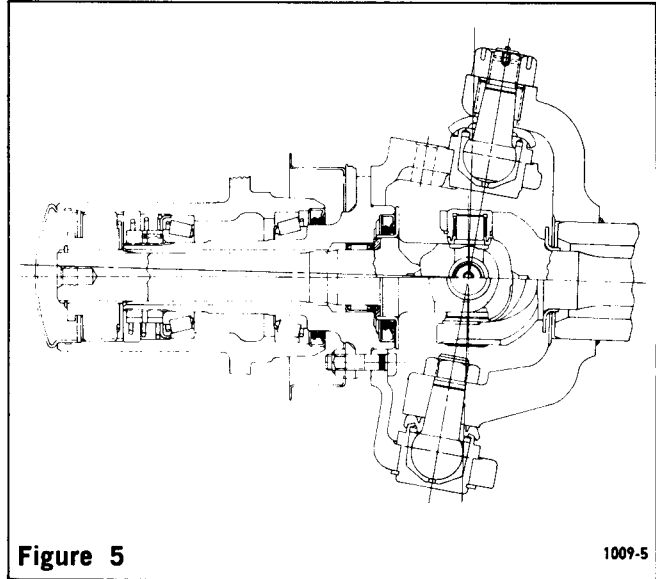

Figure 5

1009-5

## 40 DEGREE STEER WITH INTERNAL HUBS

# FRONT AXLE



Figure 6

1009-6

Remove hub cap and snap ring.

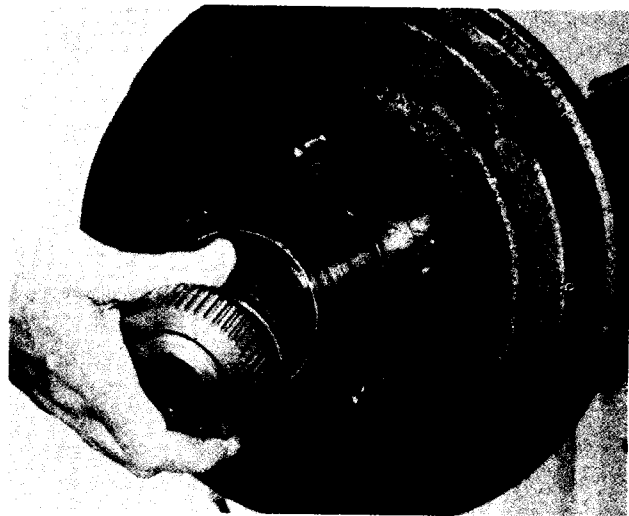
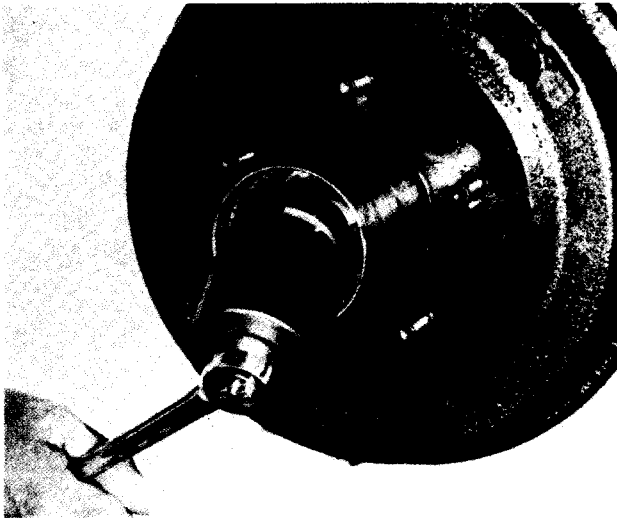

Figure 7

1009-7

Remove drive gear and pressure spring. If drive gear is stuck to the shaft, use a screw driver to pry out gear.

# FRONT AXLE

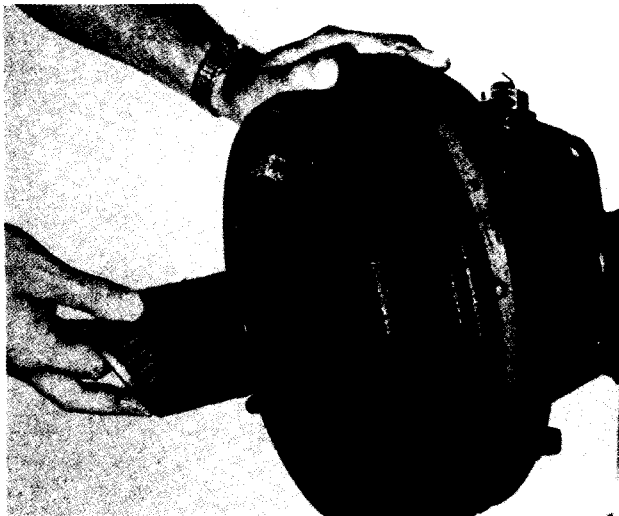

**Figure 8**

1009-8

Remove wheel bearing lock nut, lock ring and the wheel bearing adjusting nut.

Tool—#C-4170 Wheel bearing wrench.



**Figure 9**

1009-9

Remove hub and drum assembly. Spring retainer and outer wheel bearing will slide out as drum is removed.

## NOTE

If it is necessary to replace brake components such as drum, shoes, backing plate, etc., refer to vehicle service manual.

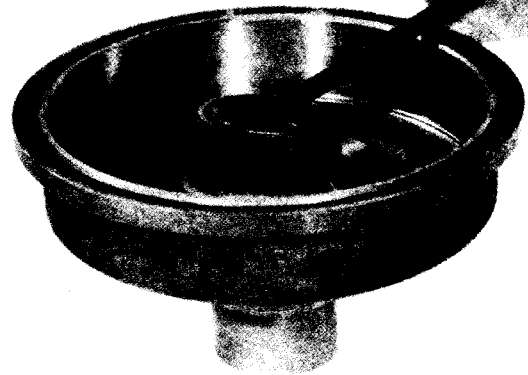

**Figure 10**

1009-10

Remove hub grease seal and inner wheel bearing cone.

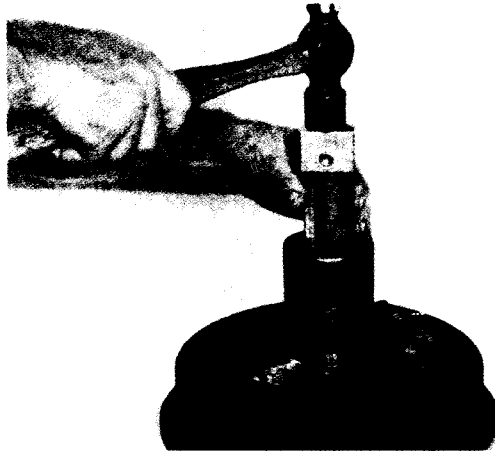
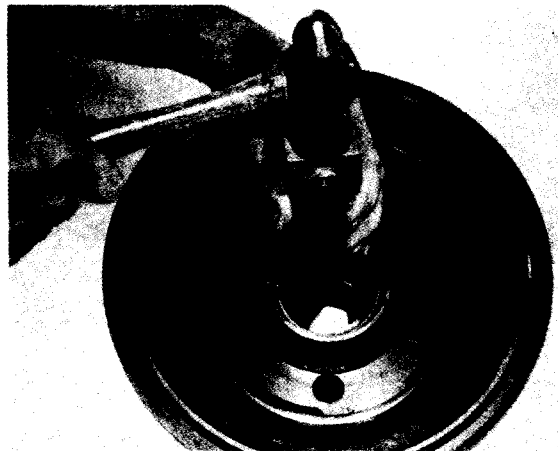

**Figure 11**

1009-11

Remove inner wheel bearing cup.

Tool—#C-4049 Wheel bearing cup remover.



**Figure 12**

1009-12

Remove outer wheel bearing cup.

Tool—#C-4049 Wheel bearing cup remover.

# FRONT AXLE

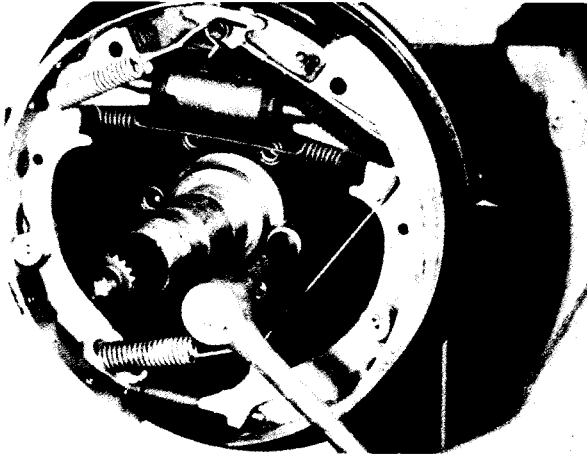

Figure 13

1009-13

Remove backing plate screws and remove backing plate.

### NOTE

The brake backing plate assembly can be retained with screws or nuts. If the nuts are of the torque prevailing design, they are to be replaced with new ones.

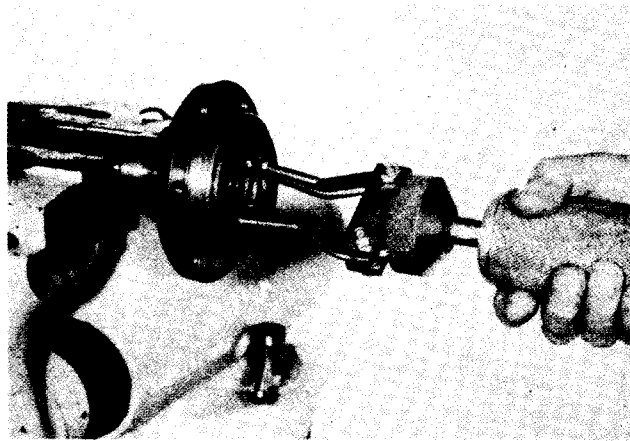

Figure 15

1009-15

Place spindle in vise. Do not locate on bearing diameters.

Remove grease seal. Discard seal.

Tool—#D-131 Slide hammer.

### NOTE

Be sure that vise jaws are equipped with brass protectors or similar type to protect the machined surfaces of any parts that are to be placed in the vise.

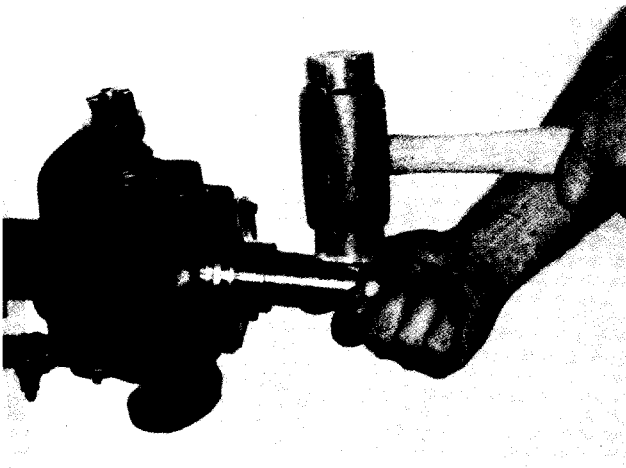

Figure 14

1009-14

Remove spindle. If necessary tap lightly with a rawhide hammer to free it from the knuckle. Check bronze spacer located between shaft joint assembly and bearing. If wear is evident, replace with a new one.

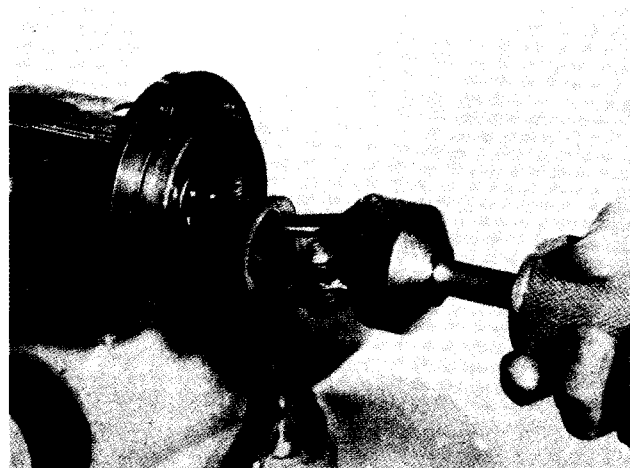

Figure 16

1009-16

Remove needle bearing. Bronze bushing may stick to the bearing as the spindle was removed, but can be removed when removing the needle bearing as shown.

Tool—#D-131 Slide hammer.



# FRONT AXLE

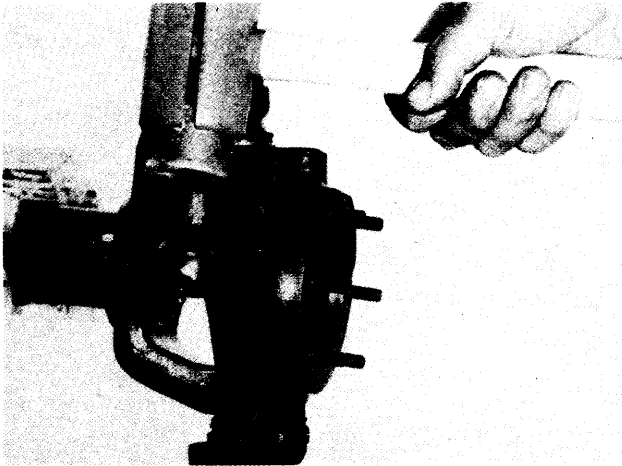

Figure 17

1009-17

Remove cotter key from tie rod nut. Remove nut. Tap on tie rod stud to free it from the steering arm.

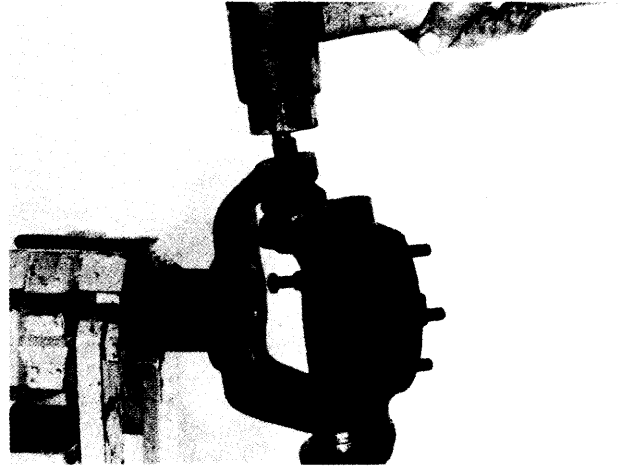

Figure 19

1009-19

Using a rawhide hammer, hit sharply on the top stud to free the knuckle from the tube yoke. After knuckle is free from the yoke, remove both the top and bottom nuts. **Discard bottom nut.** The nut on the bottom socket is of the torque prevailing design and is not to be reused.

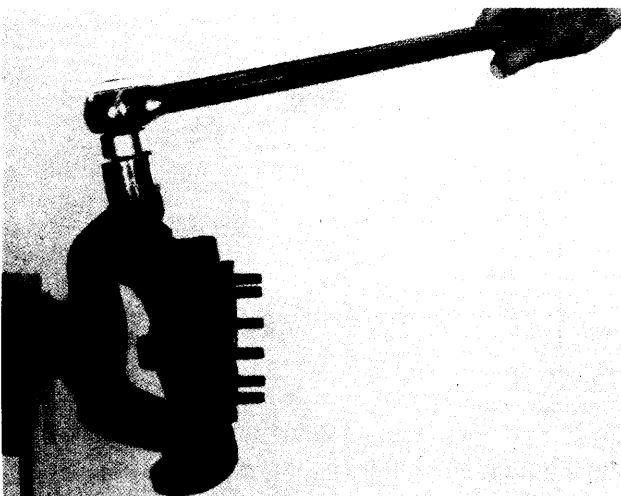

Figure 18

1009-18

Remove cotter key from top socket. Loosen both the top and bottom nuts.

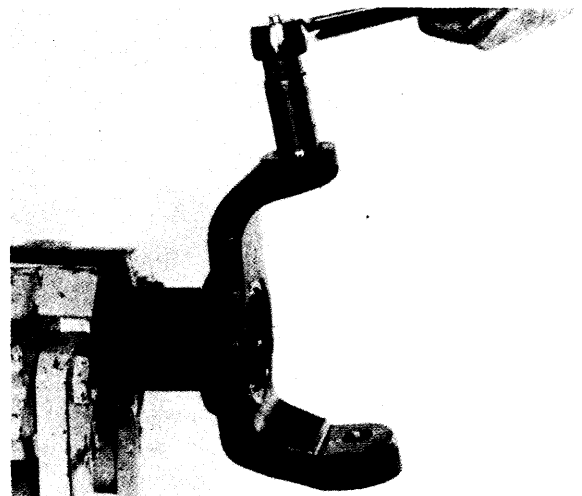

Figure 20

1009-20

Remove threaded sleeve from yokes with Tool #C-4169 socket wrench.

# FRONT AXLE

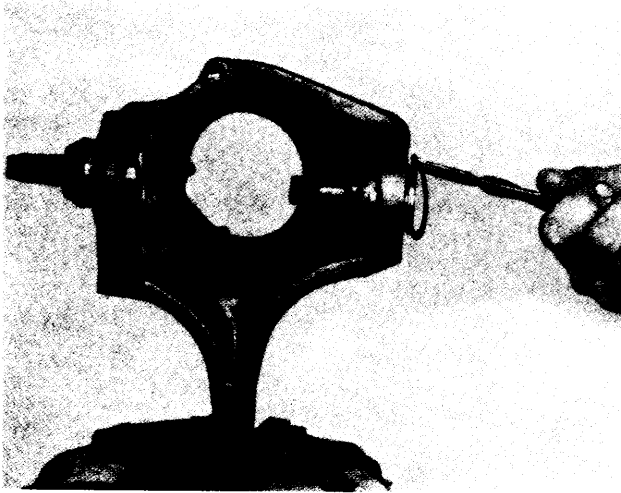

Figure 21

1009-21

Place knuckle in vise as shown. If bottom ball socket is equipped with a snap ring, remove as shown.

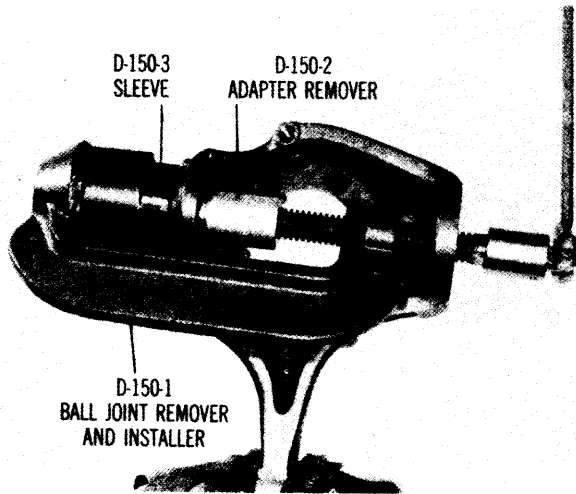

Figure 23

1009-23

Assemble ball socket tools as shown. Turn forcing screw and push out top socket.

## Discard Ball Socket

Tools—#D-150-1 Ball Joint Remover & Installer, #D-150-2 Adapter Remover, and #D-150-3 Sleeve.

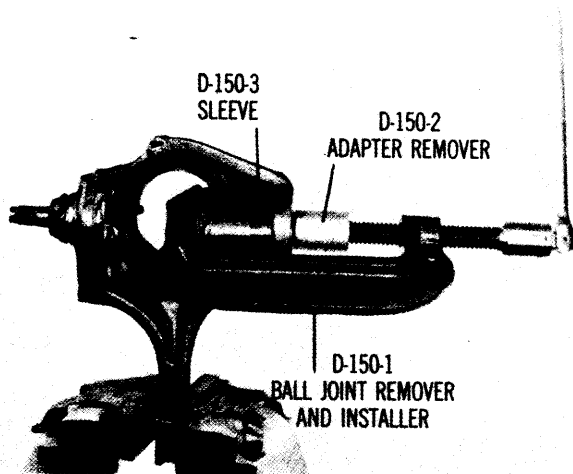

Figure 22

1009-22

**NOTE: BOTTOM BALL SOCKET MUST BE REMOVED BEFORE THE TOP BALL SOCKET CAN BE REMOVED.**

Assemble ball socket tools as shown. Turn forcing screw and push out bottom socket.

## DISCARD BALL SOCKET

Tools—#D-150-1 Ball Joint Remover & Installer, #D-150-2 Adapter Remover, and #D-150-3 Sleeve.

## ASSEMBLY

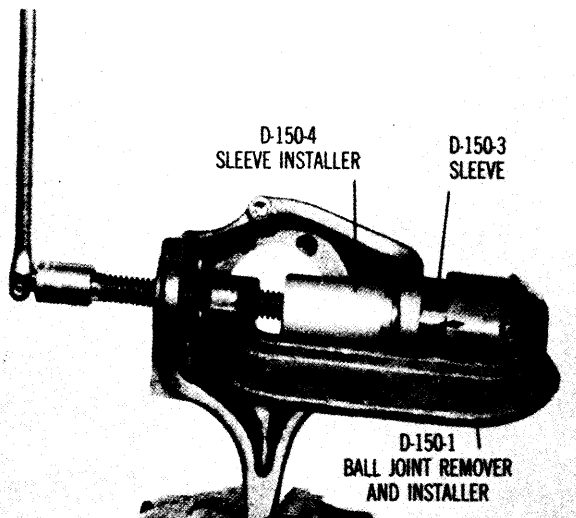

Figure 24

1009-24

(Lower ball socket does not have a cotter key hole in the stud end.)

Assemble bottom socket into the knuckle. Make sure socket is straight.

Assemble tools as shown. Turn forcing screw and push socket into knuckle as far as it will go.

Tools—#D-150-1 Ball Joint Remover & Installer, #D-150-3 Sleeve, & #D-150-4 Sleeve Installer.

# FRONT AXLE



**Figure 25**

1009-25

If required, assemble snap ring on bottom socket.

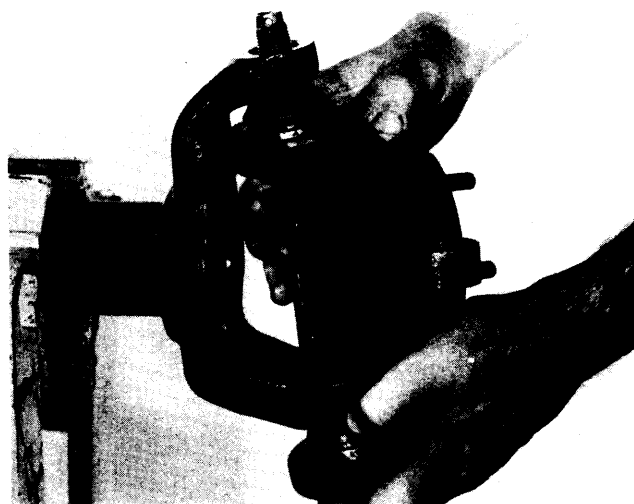

**Figure 27**

1009-27

Assemble knuckle and socket assembly to yoke as shown.

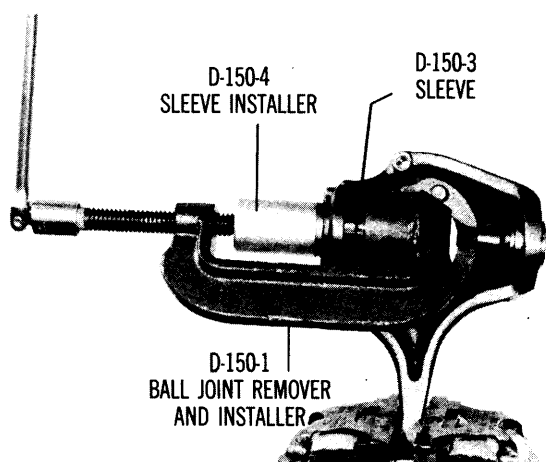

**Figure 26**

1009-26

Upper ball socket has a cotter key hole in the stud end. Assemble socket into knuckle. Make sure socket is straight.

Assemble tools as shown. Turn forcing screw and push socket into knuckle as far as it will go.

Tools—#D-150-1 Ball Joint Installer & Remover, #D-150-3 Sleeve, & #D-150-4 Sleeve Installer.

Remove tools. Make sure this area is free from dirt, etc.

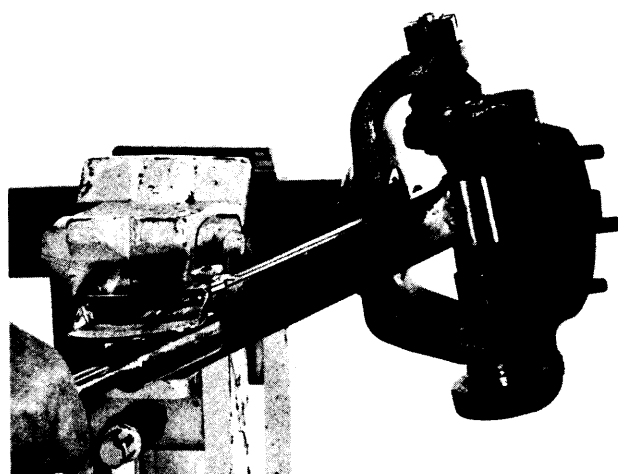

**Figure 28**

1009-28

Assemble new torque prevailing nut on bottom socket finger tight.

Assemble top nut on top socket. **Do not assemble at this time.**

Torque top nut until it is tight. This will pull the studs of the bottom socket into the tapered hole of the yoke.

Torque bottom nut to 80 lbs. ft.

Tool—#C-524-A Torque wrench.

## FRONT AXLE

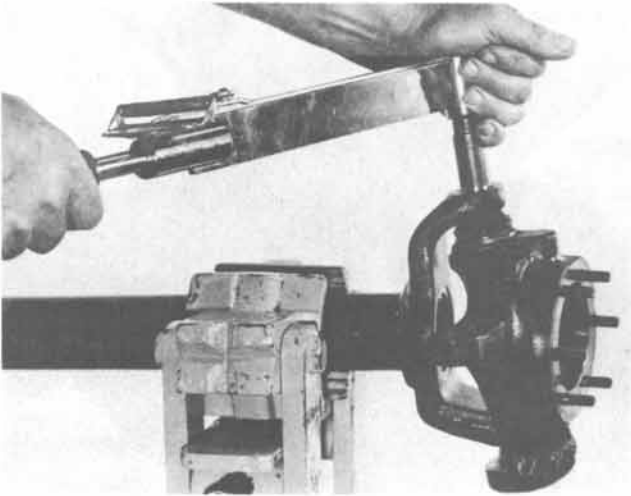

Figure 29

1009-29

Assemble new threaded sleeve into top of yoke. Using tool as shown torque sleeve to 50 lbs. ft.

Tools — #C-4169 Sleeve socket, #C-524-A Torque wrench.



Figure 31

1009-31

Assemble cotter key.

### NOTE

In the event that knuckles are received with the sockets and snap ring assembled to the knuckle, along with new top and bottom nuts, split sleeve and cotter key. Follow procedures as illustrated through Figures 27 through 31 for assembly.

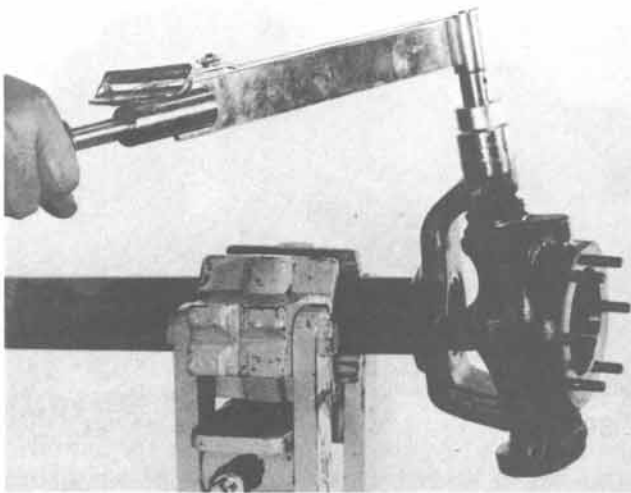

Figure 30

1009-30

Assemble top socket nut. Torque nut to 100 lbs. ft. After nut has been torqued, tighten nut to line up the cotter key hole of the stud with the next castellation or slot of the nut. **Do not loosen nut.**

Tool—#C-524-A Torque wrench.

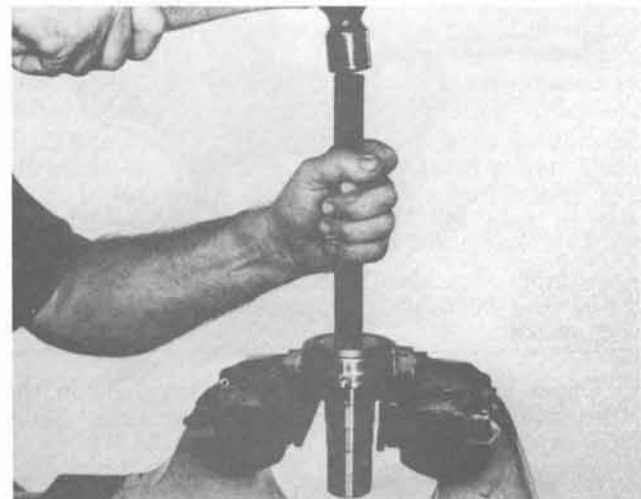
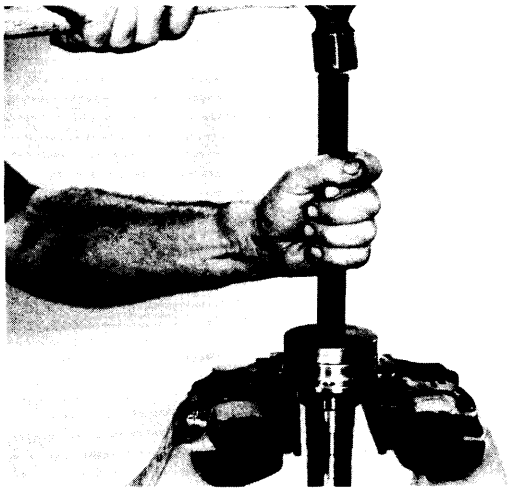

Figure 32

1009-32

Assemble new needle bearing into spindle.  
Tools—#D-122 Installer, #C-4171 Handle.

# FRONT AXLE



**Figure 33**

1009-33

Assemble new grease seal into spindle.  
Tools—#D-155 Installer, #C-4171 Handle.



**Figure 36**

1009-36

Pack the area around the thrust face area of the shaft and seal full of grease. Also, fill the seal area of the spindle with grease.

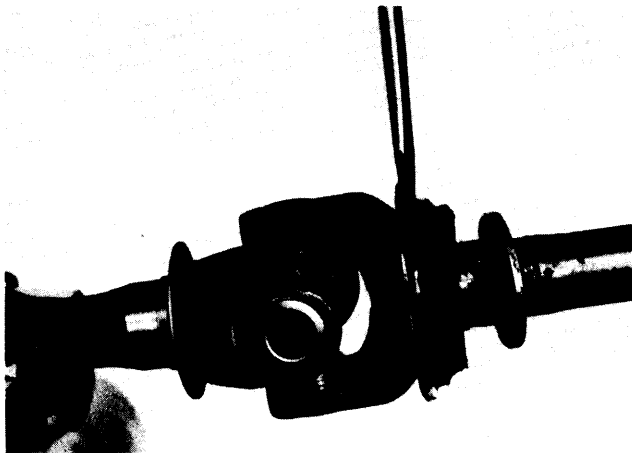

**Figure 34**

1009-34

Some front axles are equipped with a "V" seal which is assembled to the axle shaft stone shield as shown. If seal is worn, remove and replace with a new one.



**Figure 35**

1009-35

Assemble new seal as shown. Lip of the seal is to be directed towards the spindle.

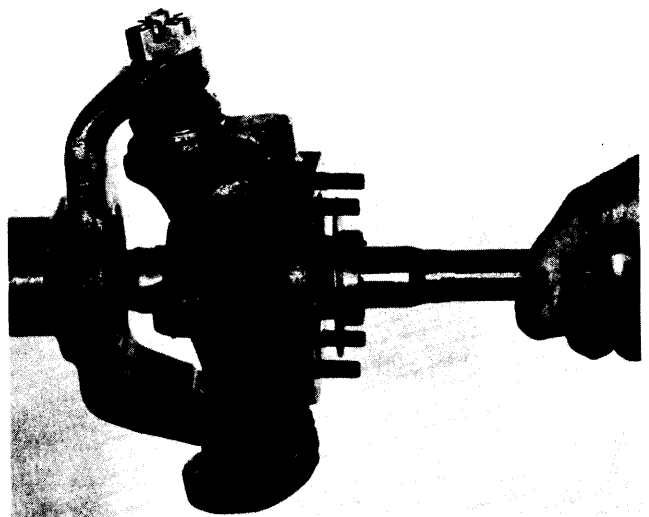
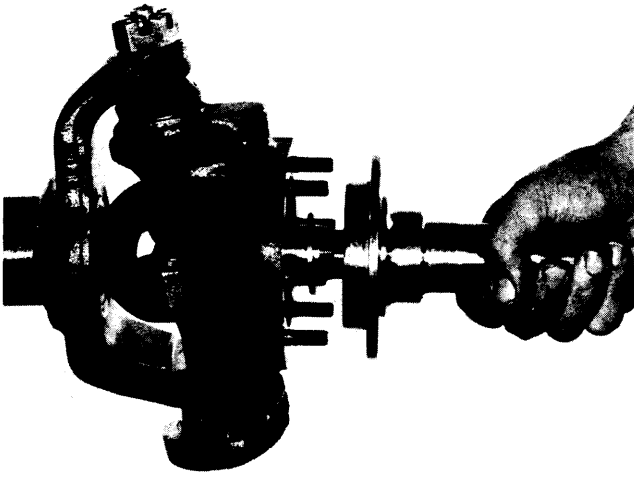

**Figure 37**

1009-37

Assemble axle shaft joint assembly into tube.

# FRONT AXLE



**Figure 38**

1009-38

Assemble new bronze spacer and spindle.

## NOTE

Be sure chamfer end of spacer is directed toward the seal slinger of the axle shaft joint.

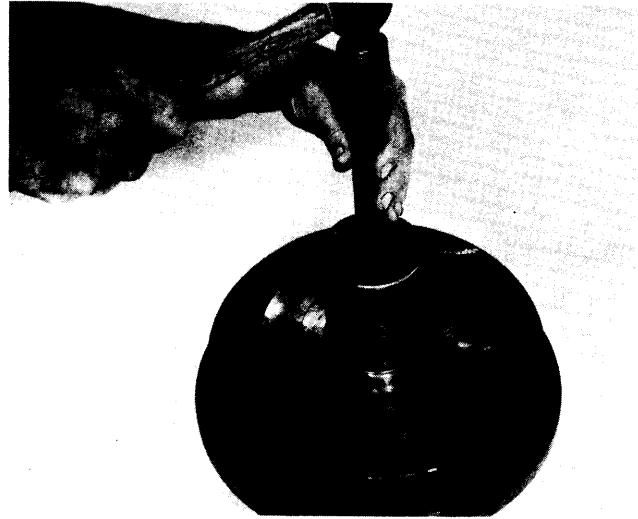

**Figure 40**

1009-40

Assemble new outer wheel bearing cup.  
Tools—#D-140 Installer, #C-4171 Handle.

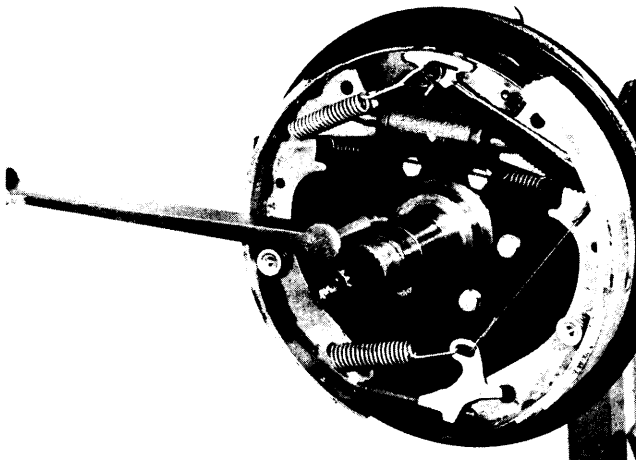

**Figure 39**

1009-39

Assemble brake backing plate assembly. Assemble new nuts. Torque nuts to 25-30 lbs. ft.  
Tool—#C-524-A Torque wrench.

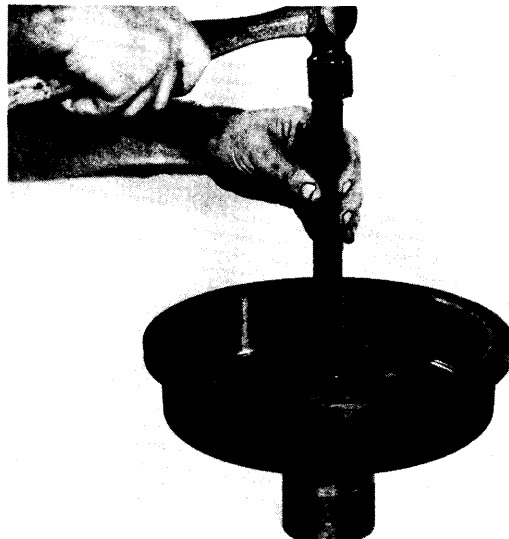
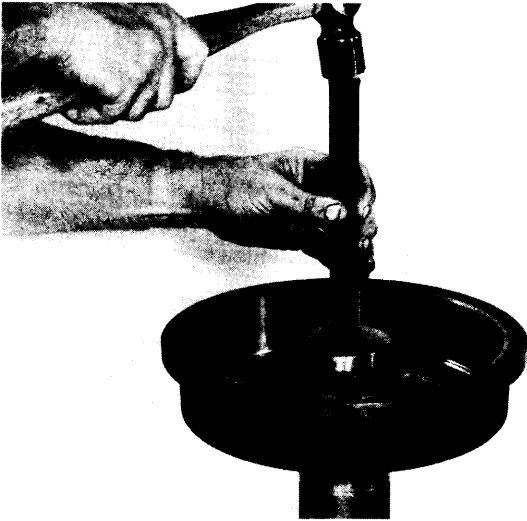

**Figure 41**

1009-41

Assemble new inner wheel bearing cup.  
Tools—#D-153 Installer, #C-4171 Handle.

# FRONT AXLE



**Figure 42**

1009-42

Assemble new wheel bearing grease seal.  
Tools—#D-155 Installer, #C-4171 Handle.

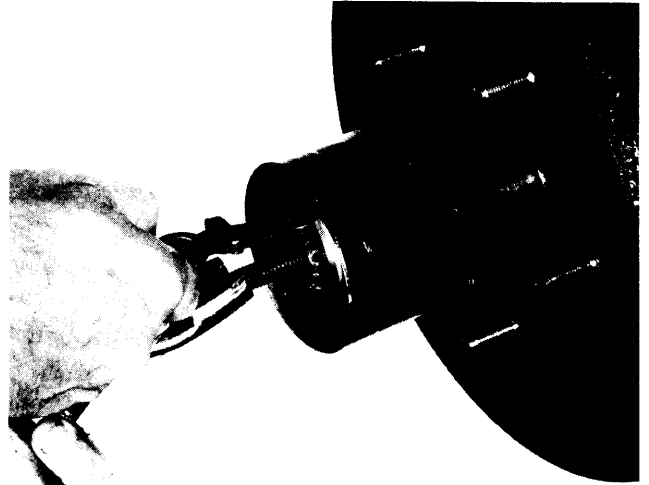

**Figure 44**

1009-44

Assemble drive gear and snap ring. Assemble bolt into shaft. Pull on bolt, push on gear to allow clearance of the snap ring groove. Be sure snap ring is seated in snap ring groove.



**Figure 43**

1009-43

Assemble brake drum and outer wheel bearing cone to spindle. Assemble inner wheel bearing adjusting nut. Torque nut to 50 lbs. ft. Rotate hub, then back off nut 90° maximum. Assemble lockwasher, line tap up with keyway of spindle, turn nut to nearest hole of the lockwasher. Assemble outer locknut. Torque nut to 50 lbs. ft. minimum.

Tool—#C-4170 Wheel bearing wrench.

## 40 DEGREE STEER— INTERNAL HUBS WITH DISC BRAKES DISASSEMBLY

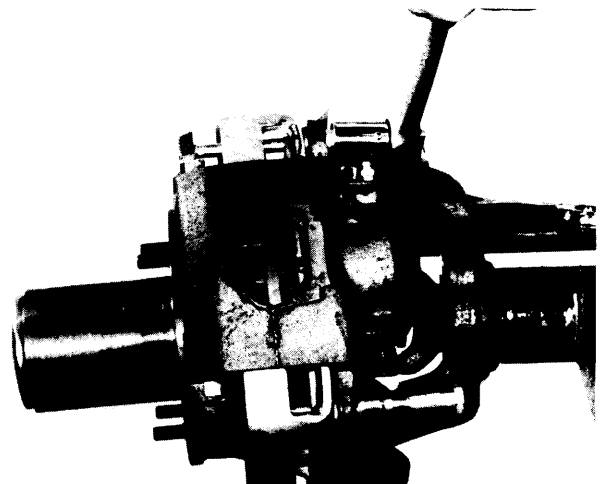

**Figure 45**

1009-45

Remove both brake caliper assembly bolts.

# FRONT AXLE

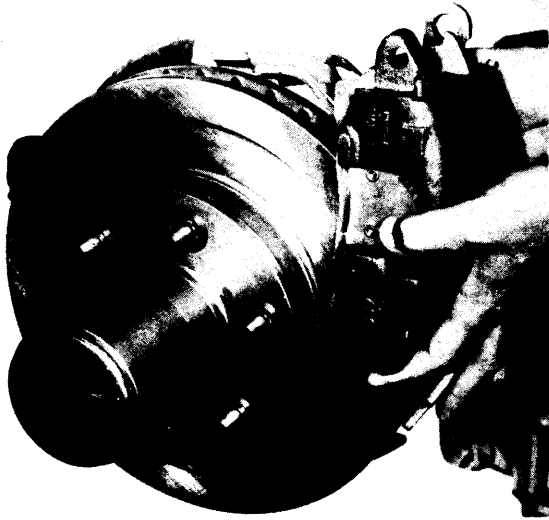

Figure 46

1009-46

Remove brake caliper assembly.

To remove the hub and brake disc assembly follow the same procedures as illustrated in Figures 7 thru 9.

To remove wheel bearings and seal from the hub follow the same procedures as illustrated in Figures 1009-10 thru 1009-12.

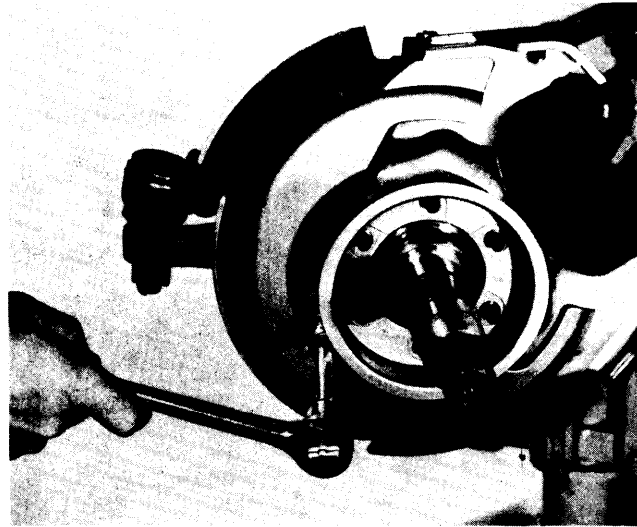

Figure 48

1009-48

Remove shield bolt which is retained in the knuckle.

Remove shield and bracket assembly from spindle.

To remove spindle, spindle seals, spindle bearings and axle shaft joint assembly, follow the same procedures as illustrated in Figures 1009-14 thru 1009-16.

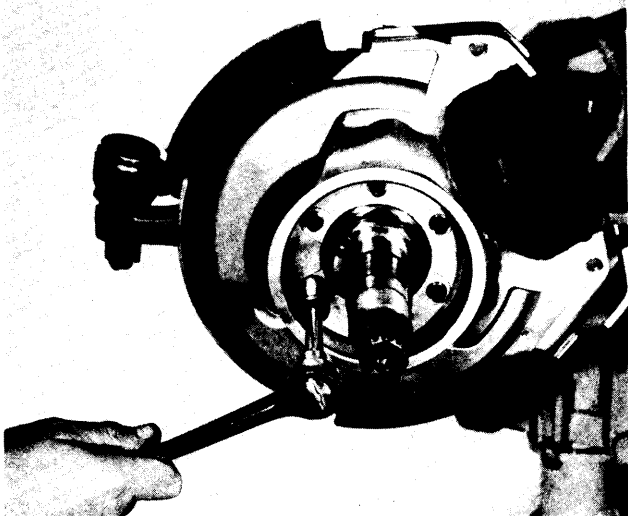

Figure 47

1009-47

Remove six (6) torque prevailing nuts from brake disc shield.

## NOTE

These nuts are of the torque prevailing design and should be discarded and replaced with new ones during assembly.

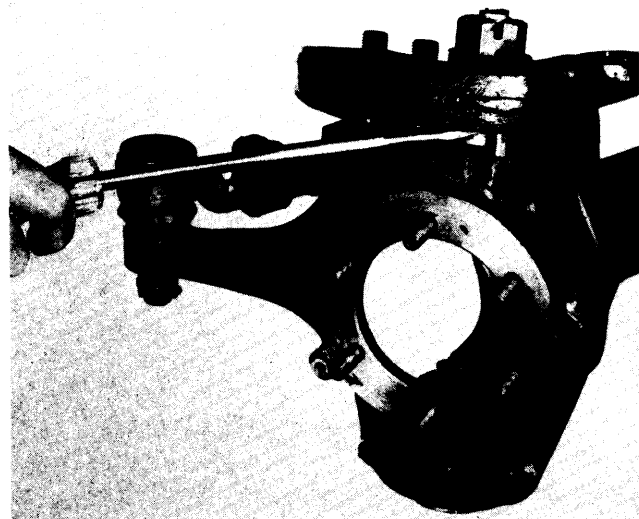

Figure 49

1009-49

Remove three steering arm nuts and cone washers and remove steering arm. Use a rawhide hammer and tap lightly on arm to free it from knuckle. Also a screw driver as shown to remove arm.

Remove cotter key, tie rod nut and remove tie rod.



# FRONT AXLE

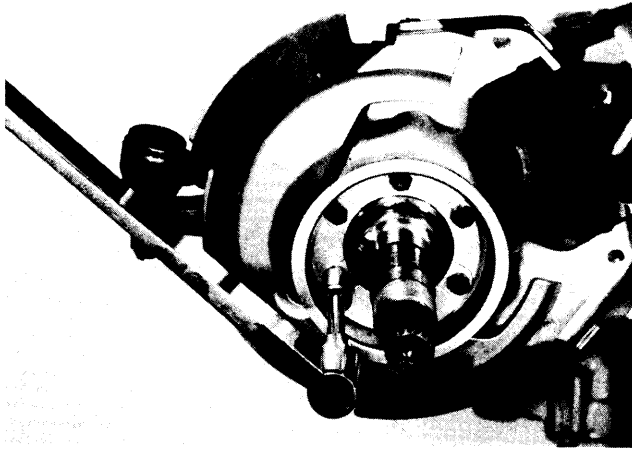
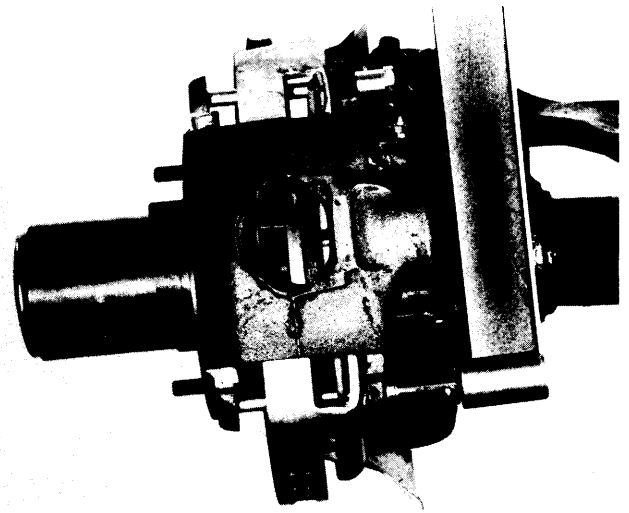

**Figure 50**

1009-50

Assemble brake shield bracket assembly to spindle using new torque prevailing nuts.

Torque nuts to 30-40 lbs. ft.



**Figure 52**

1009-52

Assemble brake caliper bolts. Torque bolts to 30-40 lbs. ft.

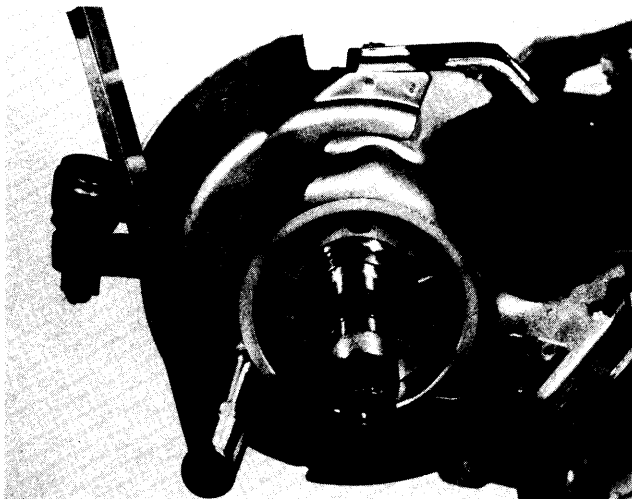

**Figure 51**

1009-51

Assemble shield bolt to knuckle. Torque bolt to 5-10 lbs. ft.

To assemble new wheel bearings and new seal to hub and brake disc assembly, follow the same procedure as illustrated in Figures 1009-40 thru 1009-42.

## 40 DEGREE STEER WITH EXTERNAL HUBS DISASSEMBLY

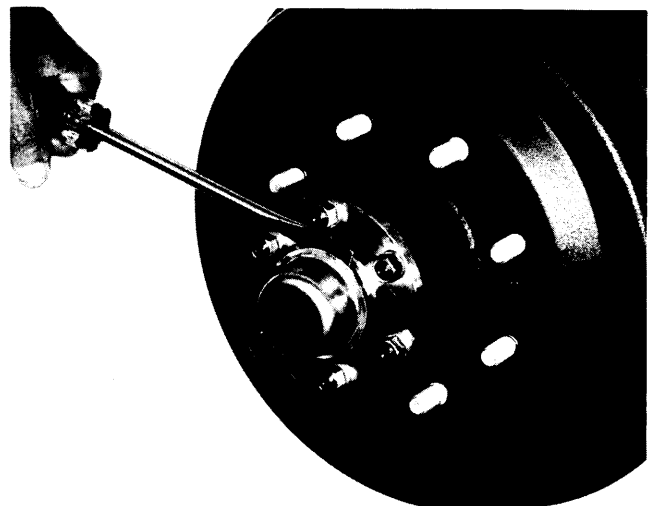
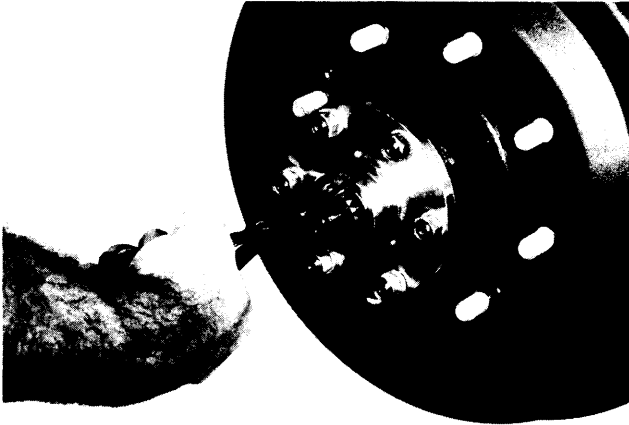

**Figure 53**

1009-53

Remove hub cap.

# FRONT AXLE



**Figure 54**  
Remove snap ring.

1009-54

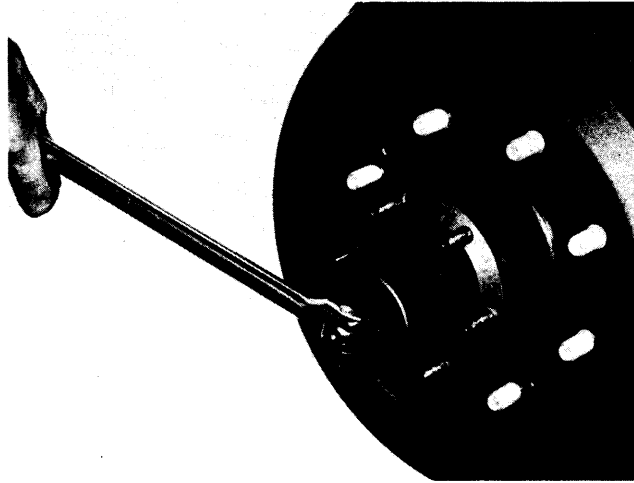

**Figure 57**

1009-57

Remove outer lock nut, lock ring, and wheel bearing adjusting nut.

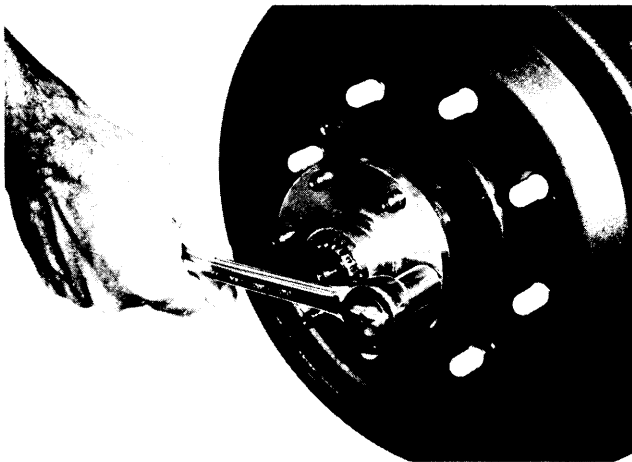

**Figure 55**  
Remove six flange nuts and lockwashers.

1009-55

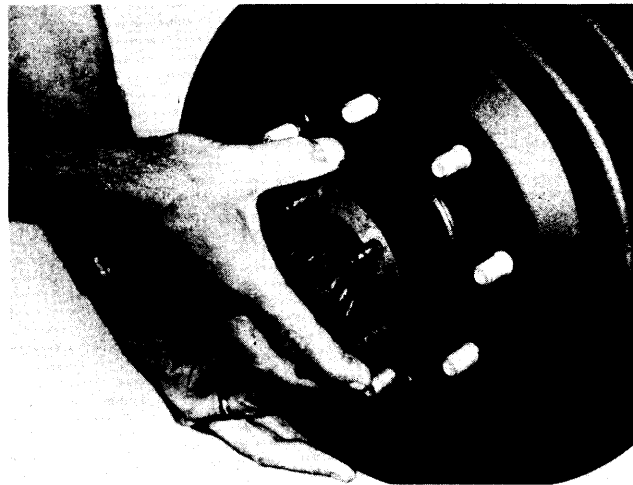

**Figure 58**

1009-58

Remove drum assembly. Outer wheel bearing will slide out as drum is removed.

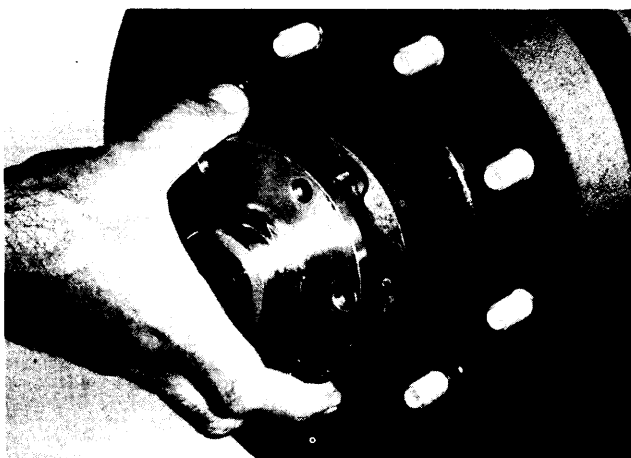

**Figure 56**  
Remove drive flange and gasket. Discard gasket. To free flange from hub, tap lightly with a rawhide hammer. Replace new gasket at time of assembly.

1009-56

## NOTE

If it is necessary to replace brake components such as drum, shoes, backing plate, etc., refer to Vehicle Service Manual.

# FRONT AXLE

## ASSEMBLY

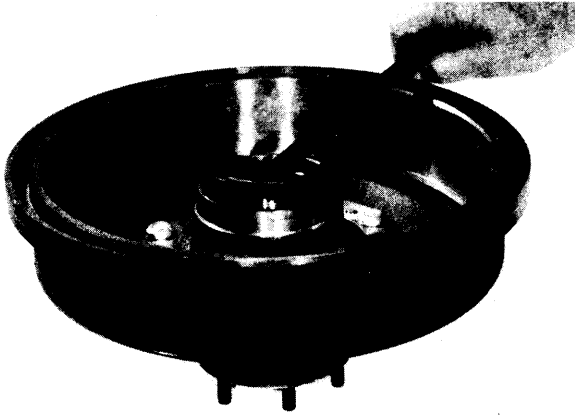

**Figure 59**

1009-59

Remove wheel bearing grease seal and inner bearing cone.

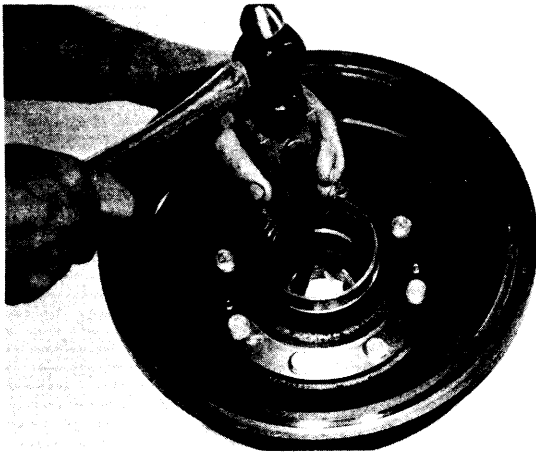
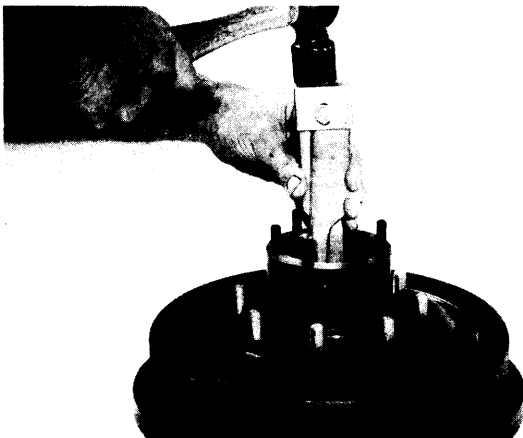

**Figure 60**

1009-60

Remove outer wheel bearing cup. Locate tool on cup and drive out.

Tool—#C-4049.

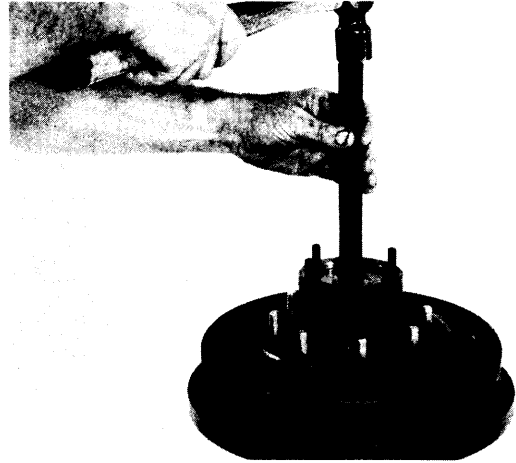

**Figure 61**

1009-61

Remove inner wheel bearing cup. Locate tool on cup and drive out.

Tool—#C-4049.

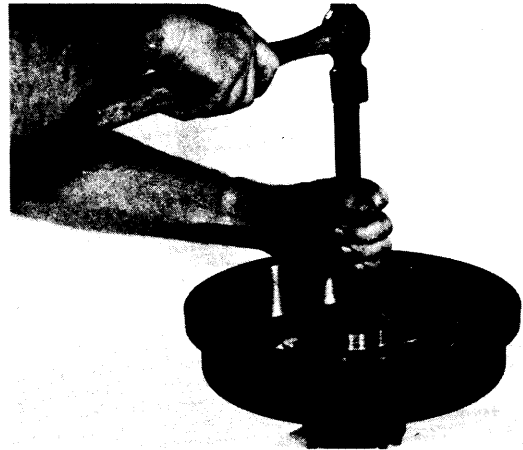

**Figure 62**

1009-62

Assemble new outer wheel bearing cup.

Tools—#C-4171 Handle, #D-140 Installer.

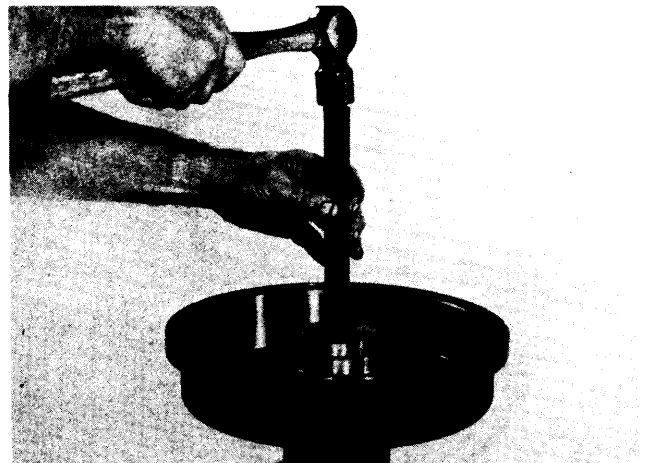

**Figure 63**

1009-63

Assemble new inner wheel bearing cup.

Tools—#C-4171 Handle, #D-154 Installer.



**Figure 64**

1009-64

Assemble new wheel bearing grease seal.

Tools—#C-4171 Handle, #D-155 Installer.

# FRONT AXLE

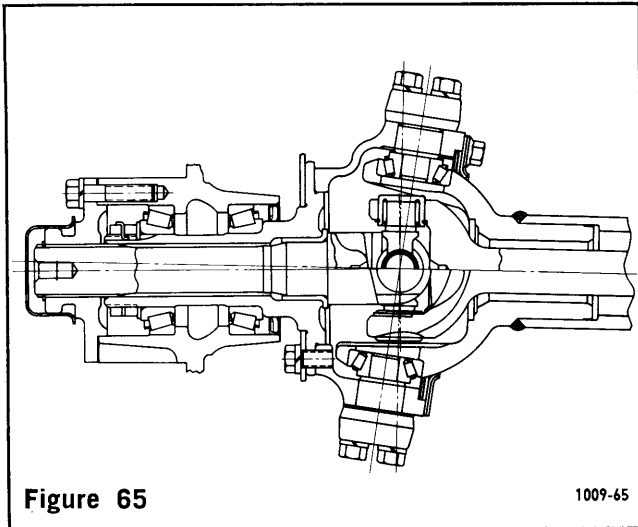

LD-65.

## ASSEMBLY

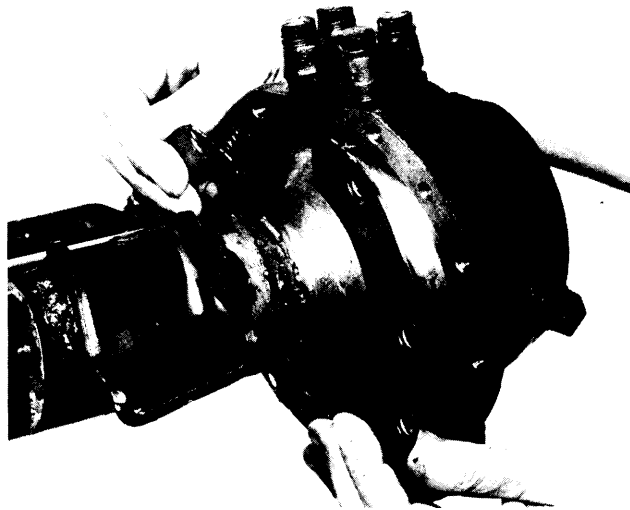

Figure 67

1009-67

Assemble new unitized seal by spreading split over tube as shown, with rubber portion towards knuckle. Be sure split of seal is at the top side of knuckle. Do not spread seal further than necessary.

Assemble new tensil lock screws. Torque screws evenly to 15-20 lbs. ft.

## KNUCKLE OIL SEAL CONVERSION

### NOTE

Some Spicer front driving axles of the closed knuckle design are available with a unitized (one piece) spherical ball knuckle oil seal.

For field conversion from the four piece seal construction (retainer plates (2), felt, and sealing ring), follow the steps as shown in Figures 1009-66 thru 1009-61. Remove retaining screws from the knuckle retaining plates.

Discard screws and both retainer plates.

### NOTE

It is recommended that when the seal is disassembled from the knuckle for any reason, the seal is to be replaced along with new screws.

## CLOSED TYPE KNUCKLE STANDARD VERSION DISASSEMBLY

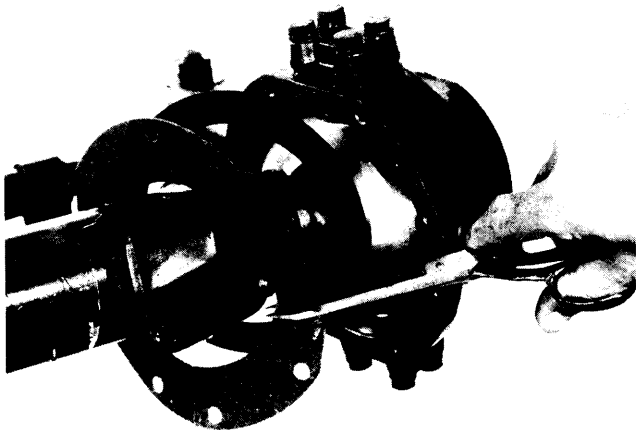

Figure 66

1009-66

Cut felt seal in half as shown and discard. Spread split of old sealing ring over tube and discard.

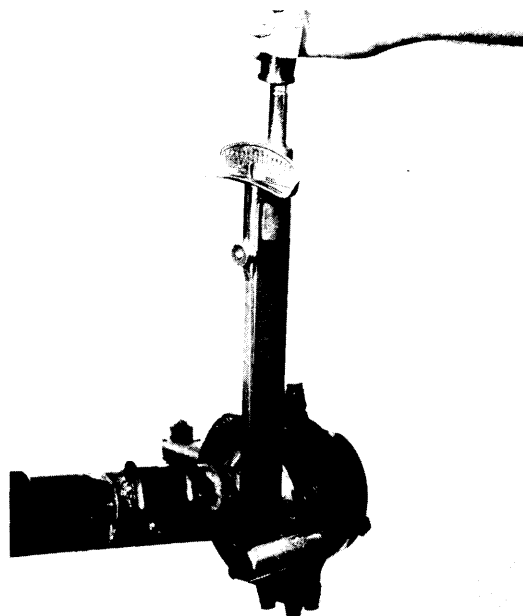

Figure 68

1009-68

# FRONT AXLE

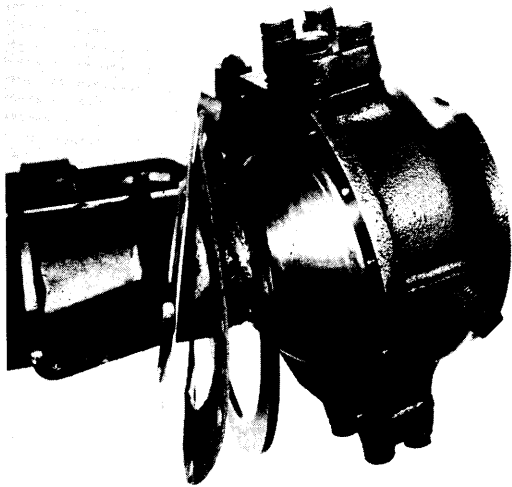

Figure 69

1009-69

Remove eight cap screws from knuckle. Remove two retainer plates, felt and seal. Discard plates, felt and seal. They are to be replaced with new parts.

Cut felt in half to remove over tube. Spread seal far enough to slip over tube.

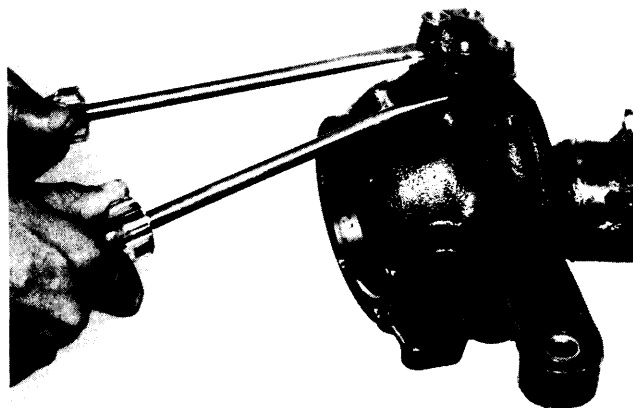

Figure 71

1009-71

Pry bearing caps loose with screwdrivers if necessary. When removing knuckle, the bottom bearing may fall out. To prevent damage, catch the bearing by hand.

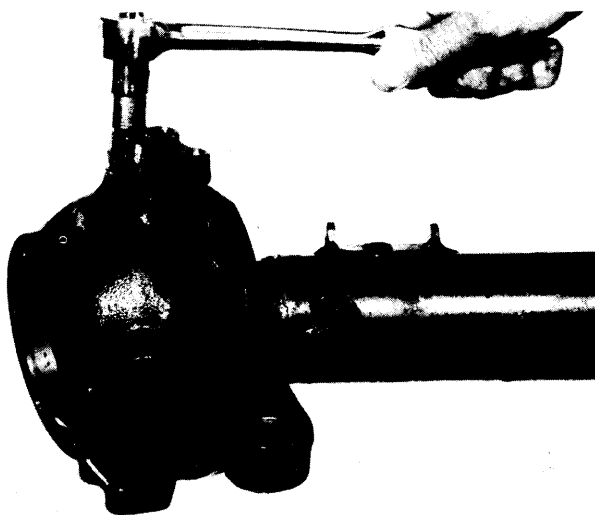

Figure 70

1009-70

Remove cap screws from the top and bottom bearing caps and nuts from steering arm if so equipped. Shims are located on the top bearing cap between the knuckle and cap. These shims control the king pin bearing preload. Save these shims since they will be required at time of assembly.

## NOTE

Some front axles are designed with a bronze bushing in the top king pin instead of a roller bearing. Bushing can be either the spline or key design.

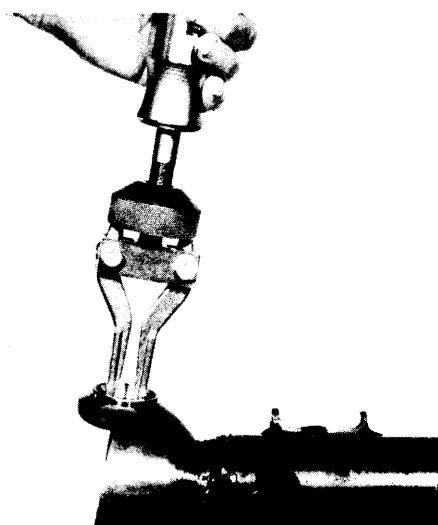

Figure 72

1009-72

Remove bearing cups from ball yoke, using puller as shown.

Tool—#D-131 Slide hammer.

# FRONT AXLE

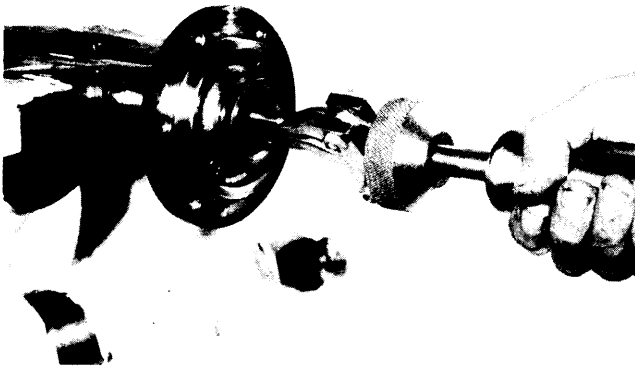

**Figure 73**

1009-73

Place spindle in vise. Do not clamp on bearing diameters. Remove bronze bushing using puller. Tool—#D-131 Slide hammer.

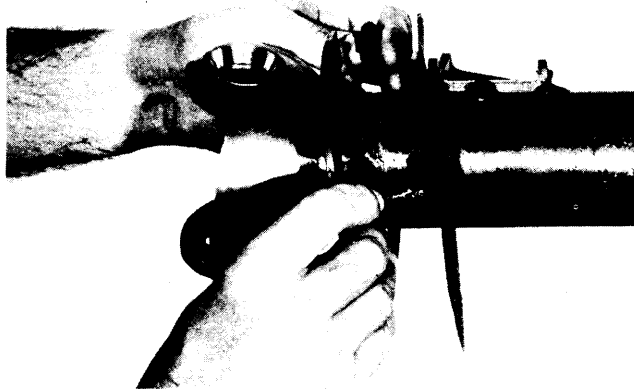

**Figure 76**

1009-76

Assemble new seal over tube. Spread seal just enough to clear tube; otherwise, it may become distorted. Metal portion of seal is to be towards the knuckle.

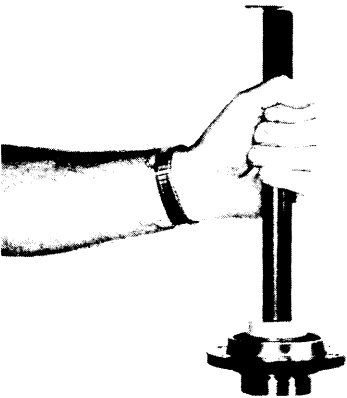

**Figure 74**

1009-74

Assemble new bronze bushing. Tools—#C-4171 Handle, #D-141 Installer. If needle bearing is used, use tool as shown in Figure 1009-32.

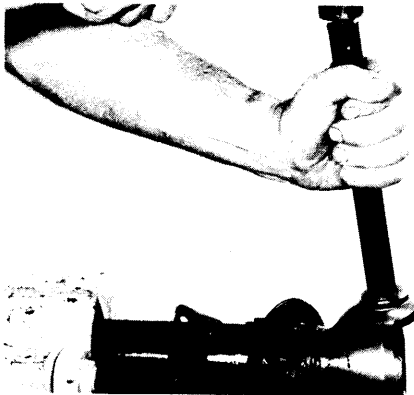

**Figure 77**

1009-77

Assemble new king pin bearing (top and bottom) into ball yoke. Tools—#C-4171 Handle, #D-151 Installer.

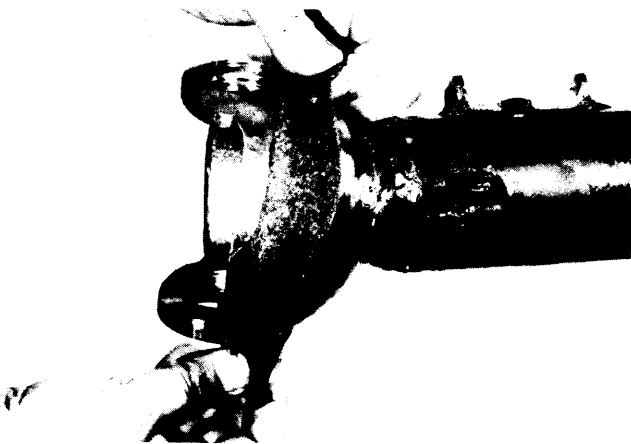

**Figure 75**

1009-75

Assemble new felt seal over ball yoke. Apply a thin coat of oil over ball to allow felt to slide and prevent it from tearing.



**Figure 78**

1009-78

Grease top and bottom bearing cones with the specified grease.

Assemble bottom bearing cap and bearing to knuckle. Assemble top bearing into bearing cup and assemble knuckle over ball yoke.

# FRONT AXLE

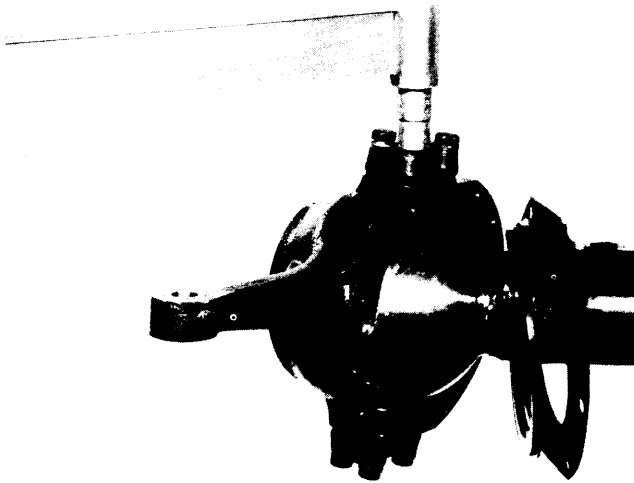

**Figure 79**

1009-79

Assemble preload shims top bearing cap on king pin. Assemble cap screws.  
Torque screws to 30-40 lbs. ft. (top and bottom).

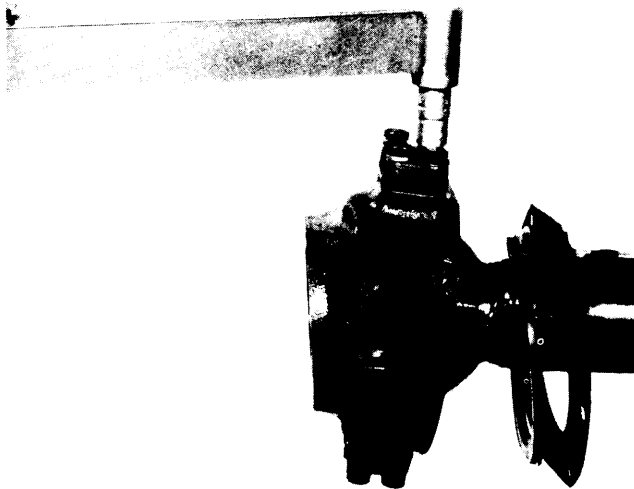

**Figure 80**

1009-80

Locate torque wrench on one screw to check for proper preload. Torque specification to rotate knuckle is 5-10 lbs. ft. If equipped with bronze bushing, torque specification is 10-20 lbs. ft. starting torque.

To increase torque reading, remove shims; to decrease torque reading, add shims.

## NOTE

When checking king pin bearing preload, make sure the tie rod is disconnected, and also the knuckle oil seals, etc., are still disassembled.

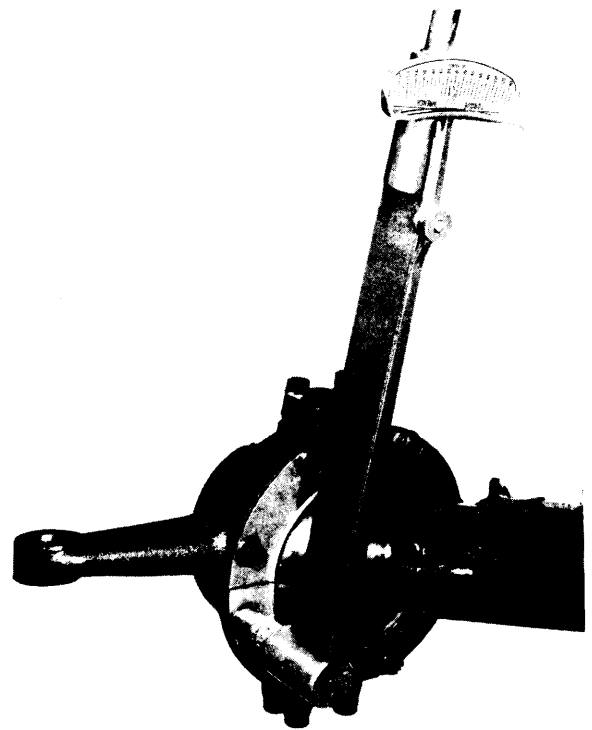

**Figure 81**

1009-81

Assemble new seal into knuckle, new felt seal, new retainer plates, and new screws. Torque screws to 10-25 lbs. ft.

Assemble axle shaft joint assembly, spindle wheel ends, etc.

Refer to Vehicle Service Manual for proper torque specification, etc.

Also, refer to Vehicle Service Manual for proper setting of toe in.

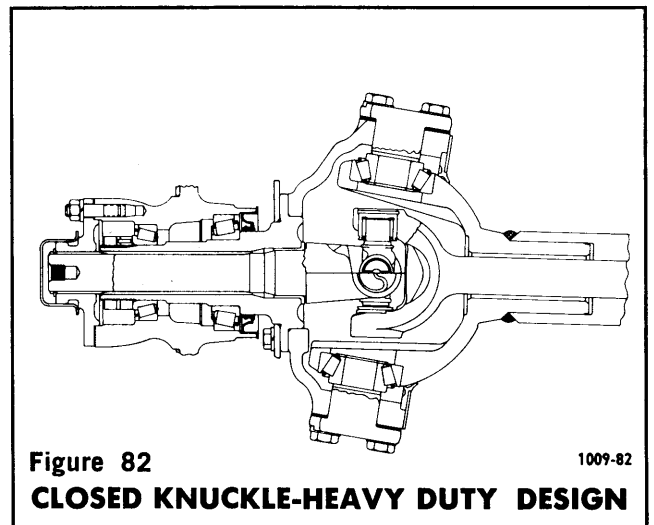

**Figure 82**

1009-82

## CLOSED KNUCKLE-HEAVY DUTY DESIGN

Remove twelve (12) cap screws which retain the oil seal to the knuckle.

# FRONT AXLE

## DISASSEMBLY

Remove four (4) cap screws from bottom bearing cap. Use a screwdriver to pry cap loose from knuckle.

The king pin bearing preload shims are located between the bottom bearing cap and knuckle as shown. Keep shims intact as they will be used later during assembly.

These shims are available in thicknesses of .003, .005, .010, and .030.

### CAUTION

When removing the knuckle the bottom bearing cone will fall out of the cup. Catch it with your hand to prevent it from becoming damaged.



Figure 83

1009-83

Remove axle shaft joint assembly.

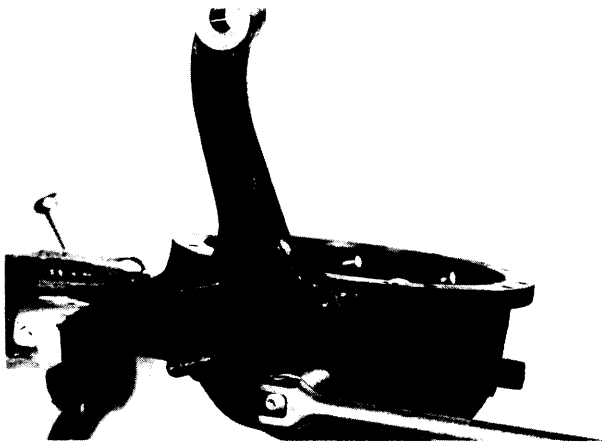

Figure 84

1009-84

Place knuckle in vise as shown. Remove the top bearing cap nuts.



Figure 85

1009-85

Remove steering arm. Tap lightly with a rawhide hammer to free it from the knuckle.

### NOTE

There is a constant shim pack between the steering arm and knuckle. This pack is to be saved and reused during assembly.

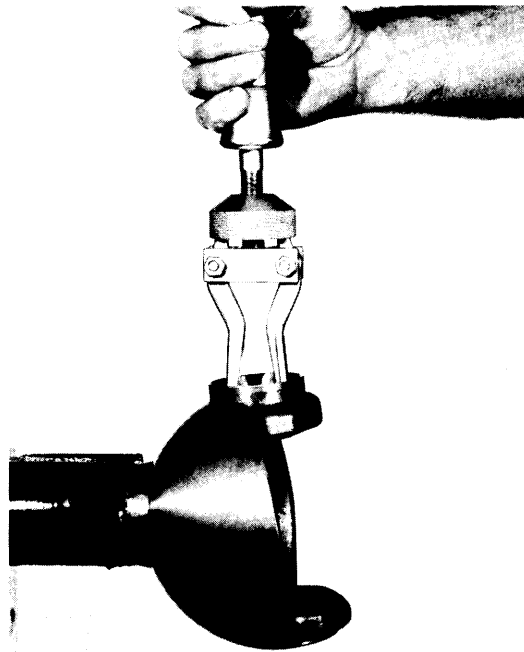

Figure 86

1009-86

Remove king pin bearing cups from spherical ball. Use puller as shown.

Tool—#D-131.

### NOTE

Some axles are equipped with a bronze bushing on the top bearing cap, instead of a roller bearing. Remove bushing by using two (2) large screwdrivers until it is free of the king pin. If woodruff key is used, discard and replace with a new one during assembly.



# FRONT AXLE

## ASSEMBLY

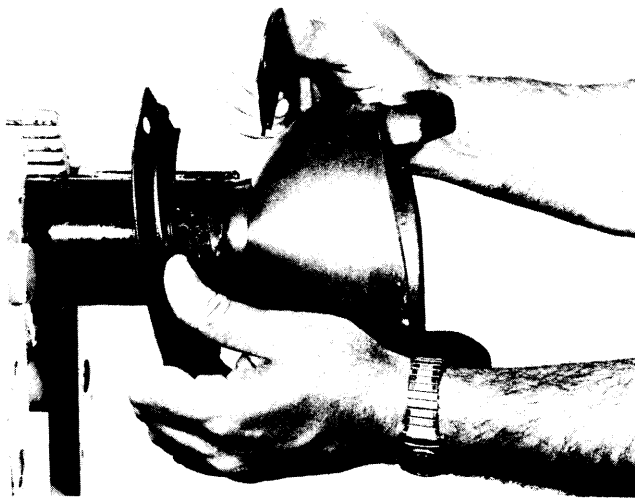

Figure 87

1009-87

Assemble new grease seal with rubber portion towards knuckle. Do not spread seal any further than necessary, this will prevent distortion of the seal.

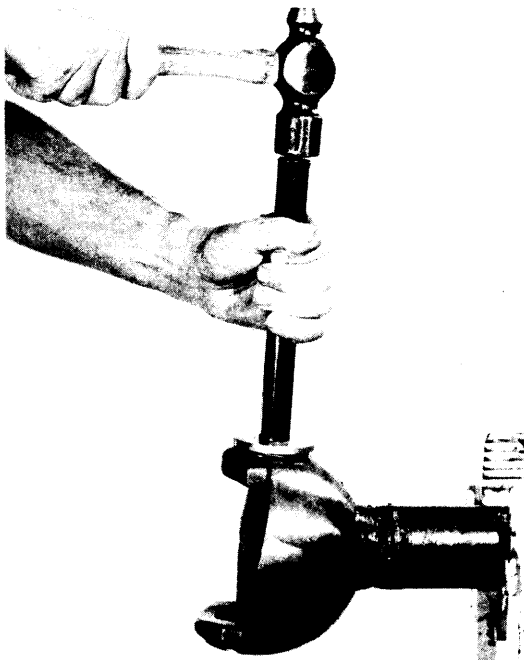

Figure 88

1009-88

Assemble new bearing cup to ball yoke.  
Tools—#C-4171 Handle, #D-142 Installer.

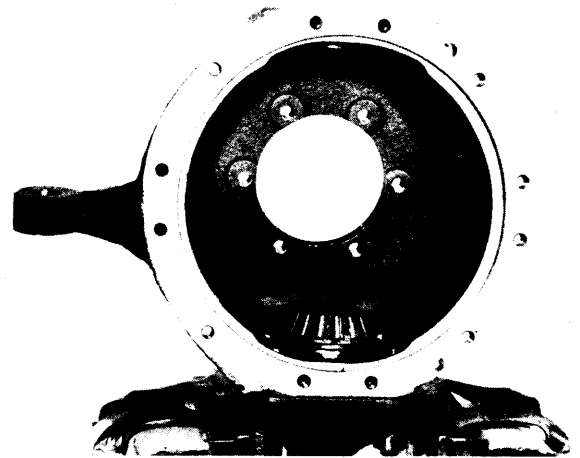

Figure 89

1009-89

Assemble steering arm king pin assembly to knuckle. Assemble new bearing cone to king pin. Grease bearing with the specified grease.

If bronze bushing is used, line up key-way of the bushing with the key-way of the pin and use new key. If bushing is of the spline design, line up the splines with those of the pin. Use a brass hammer to seat bushings.

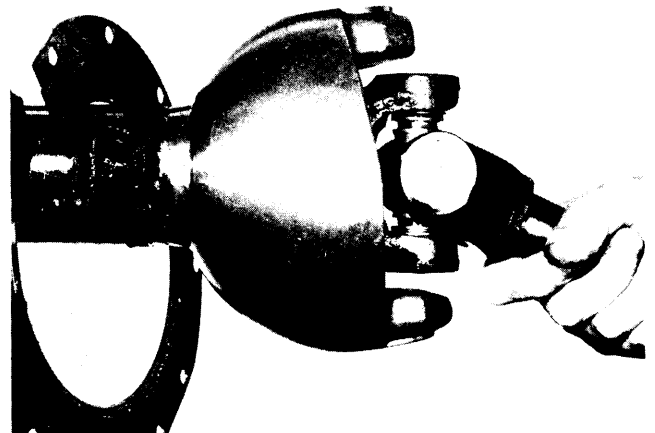

Figure 90

1009-90

Assemble axle shaft joint assembly to axle.

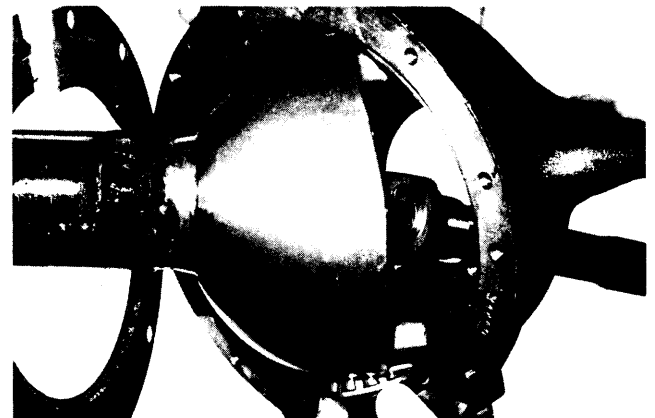
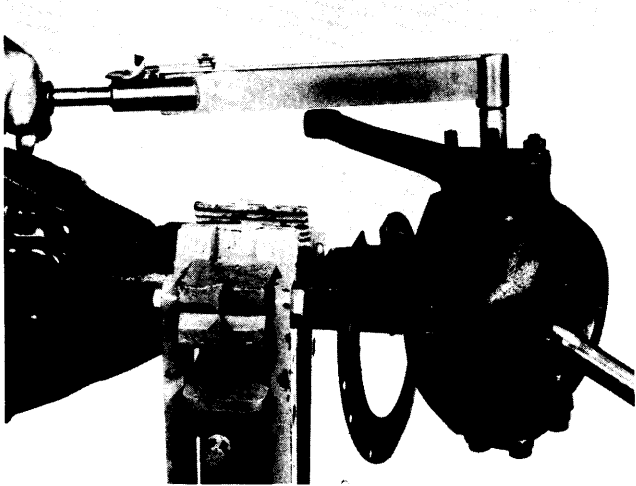

Figure 91

1009-91

Assemble knuckle to ball yoke. Hold bottom bearing as shown to prevent it from falling out.

## FRONT AXLE

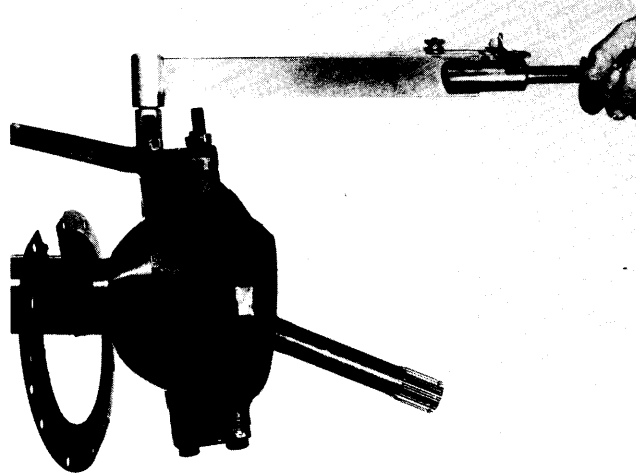

**Figure 92**

1009-92

Assemble bottom bearing cap with preload shims. Torque screws to 80-90 lbs. ft.

Torque top four (4) nuts on top bearing cap to 80-90 lbs. ft.

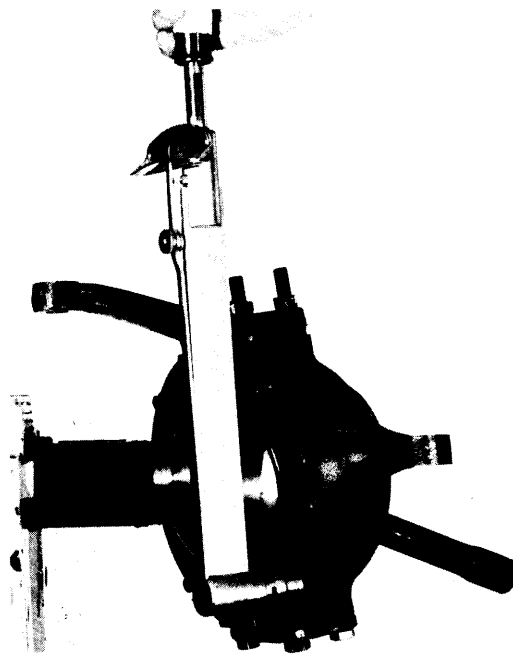

**Figure 93**

1009-93

Apply a torque wrench on one screw as shown. Torque to actuate knuckle with roller bearings is 10-15 lbs. ft. With bronze bushing 15-35 lbs. ft.

When checking torque rotation of knuckle, make sure tie rod and seals are not assembled to the knuckle.



**Figure 94**

1009-94

Assemble grease seal to knuckle. Be sure split of seal is located at the top of the axle. Torque screws to 10-15 lbs. ft.

# REAR AXLE

## UNIT WHEEL BEARING DESIGN LUBRICATED WITH HYPOID LUBRICANT

### NOTE

Unit wheel bearings that are dependent on lubrication from the hypoid gear lube in the axle housing, rather than grease, are not equipped with an inner axle shaft oil seal as shown in Figure 1009-105.

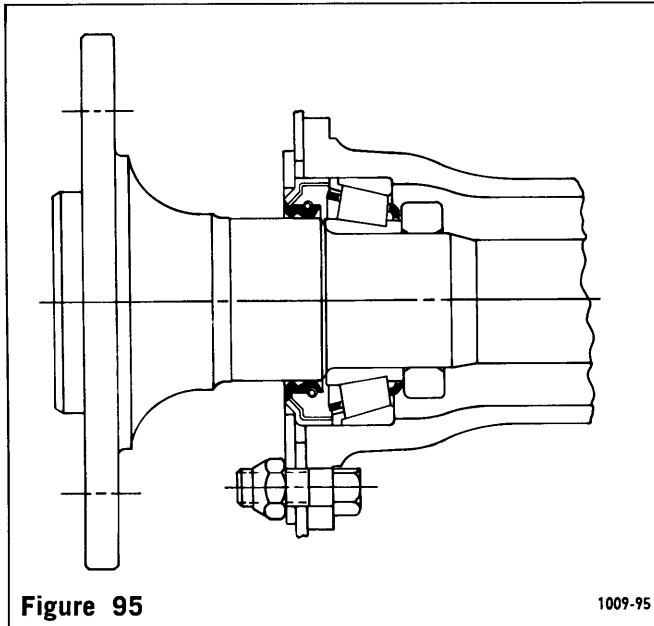

Unit wheel bearing L/D without grease seal.

## DISASSEMBLY



Figure 96

After wheel is removed, remove brake drum.

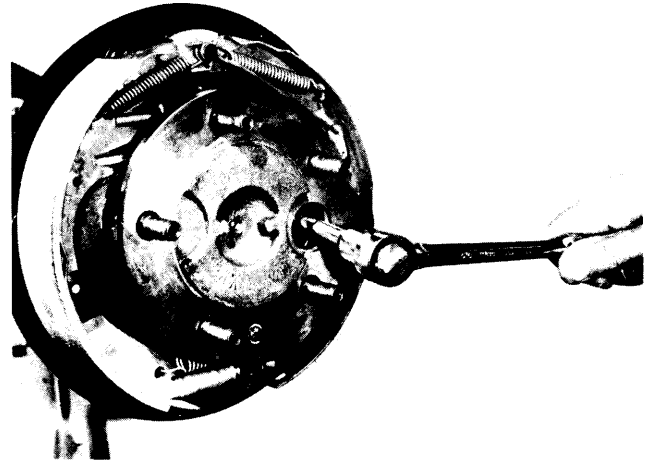

Figure 97

Remove backing plate nuts which hold the brake backing plate to the axle housing. **Discard nuts, replace with new ones at time of assembly.** Nuts are of torque prevailing design and are not to be reused.

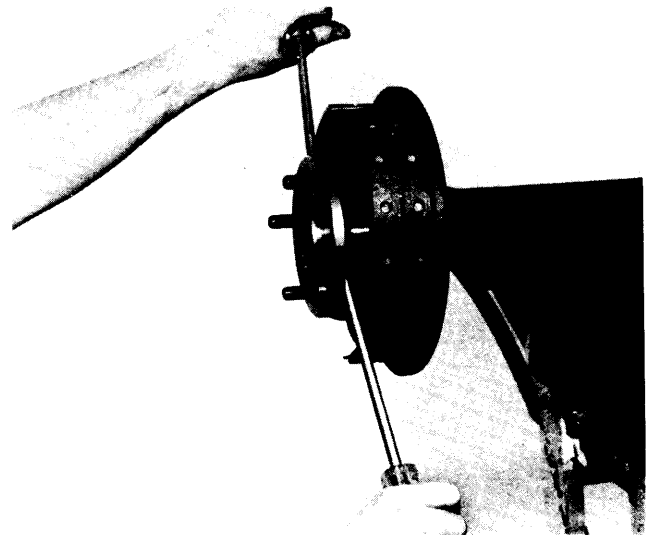

Figure 98

Remove the axle shaft by pulling on the axle. It may be necessary to free the axle by prying it loose with two screwdrivers or pry bars as shown.

### NOTE

Backing plate can normally be wired to the frame, without loosening the hydraulic brake line connection at the wheel cylinder, if desired. Use caution to avoid damage to brake line.

# REAR AXLE

## ASSEMBLY

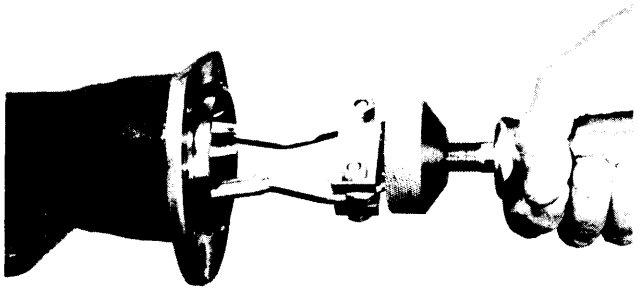

Figure 99

1009-99

The bearing cup will normally stay in place in the housing. To remove bearing cup, use puller as shown.

Tool—#D-131 Slide Hammer.

## CLEANING, INSPECTING AND RELUBRICATING WHEEL UNIT BEARING

Clean bearing cup with any of the standard metal cleaning solvents. Inspect cup for any possible wear, nicks, etc.

The cone assembly can be cleaned in place on the axle shaft. Use any standard metal cleaning solvent and a stiff bristle brush to remove any dirt or any other contamination that might be present, then use compressed air. Air should be directed at the cone assembly so that it goes through the bearing from one end of the rollers to the other. It is important not to "spin dry" the bearing with compressed air. Spinning the dry bearing may score the raceways and rollers due to lack of lubricant.

Use a standard metal cleaning solvent to clean out the bearing bore in the housing. Wipe this area clean making sure it is free from dirt or any other contamination that might be present.

After the bearing has been inspected and approved for continued service, it must be lubricated prior to installation. The bearing must be lubricated by applying a small amount of the specified lube around the rollers of the bearing cone.

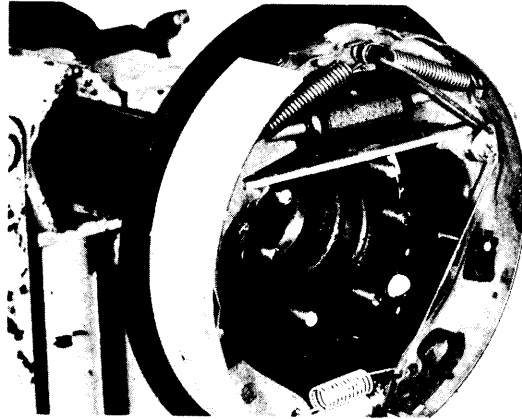

Figure 100

1009-100

Assemble backing plate bolts and backing plate assembly.

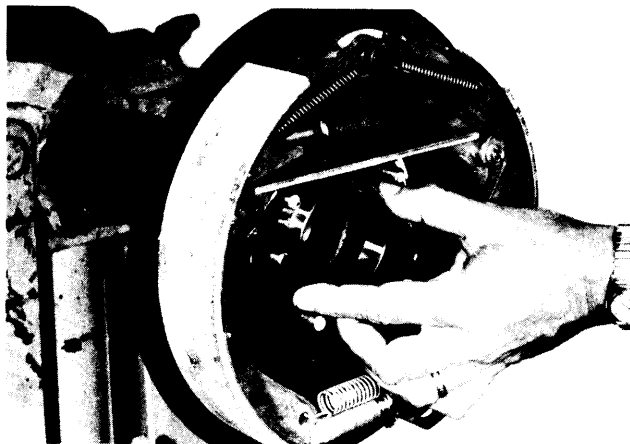

Figure 101

1009-101

Assemble bearing cup into bearing bore of the tube. Make sure the cup backface is against the bearing seat of the tube.

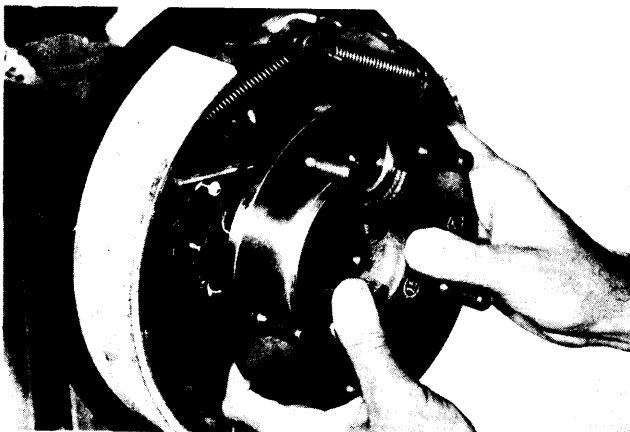

Figure 102

1009-102

Assemble axle shaft into housing. Care should be taken not to damage the bearing rollers.

Line up the holes of the retainer plate with the bolts, push axle shaft into the housing as far as possible.

## REAR AXLE

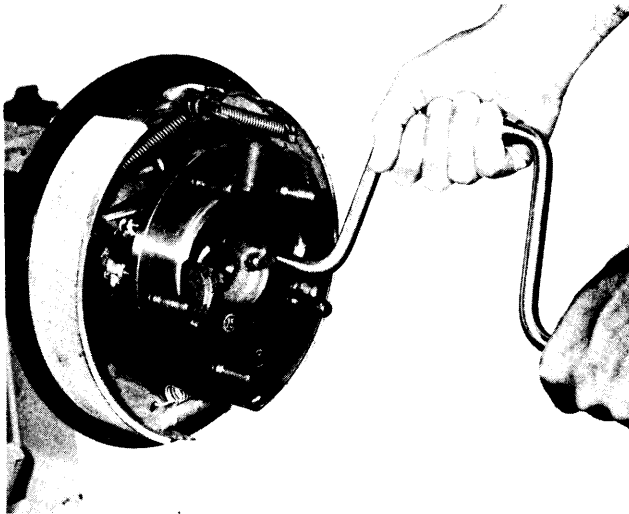

Figure 103

1009-103

Start nuts on backing plate bolts by hand. Use a speed wrench as shown and tighten to approximately 15 lbs. ft.

The nuts should be tightened in a manner that assures that the seal and cup rib ring are drawn evenly against the cup in the housing.

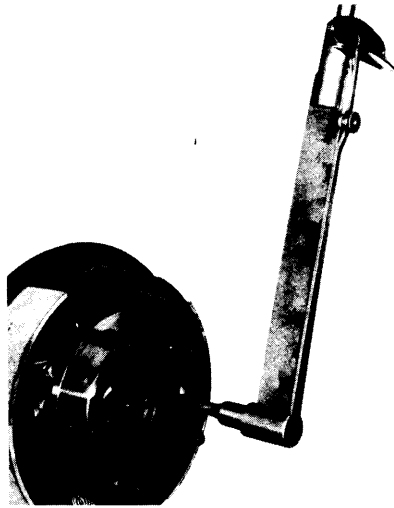

Figure 104

1009-104

Using a torque wrench as shown, torque nuts to 25-35 lbs. ft. Assembly brake drums, retainer nuts, wheels, etc.

Tool—#C-524-A Torque wrench.

### UNIT WHEEL BEARING DESIGN LUBRICATED WITH GREASE

#### NOTE

Unit wheel bearings that are dependent on grease for lubrication, rather than hypoid gear lube from the axle housing, are equipped with an inner axle shaft oil seal as shown in Figure 1009-105.

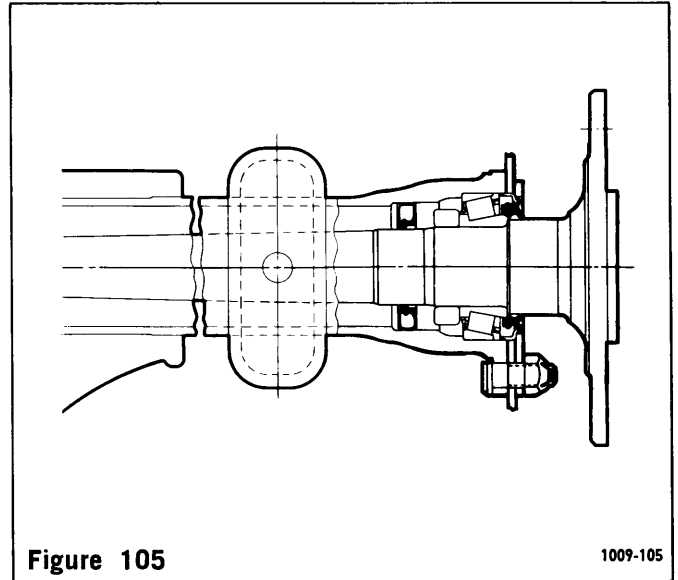

Figure 105

1009-105

Unit wheel bearing L/D with grease seal.

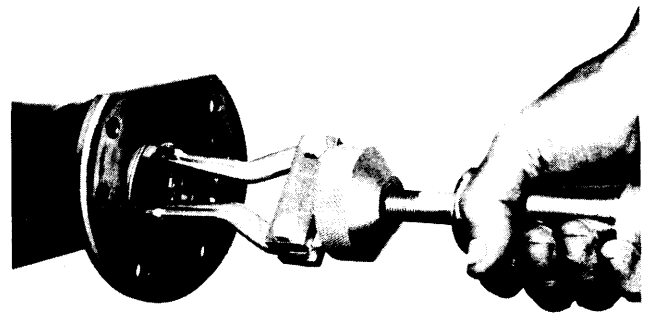

Figure 106

1009-106

Remove inner axle shaft seal using puller as shown.

Tool—#D-131 Slide hammer.

Discard seal and replace with new one at time of assembly.

#### NOTE

Avoid contacting seals with cleaning solvent in cleaning operation.

## REAR AXLE

### CLEANING, INSPECTING AND RELUBRICATING UNIT BEARINGS

Clean bearing cup with any of the standard metal cleaning solvents. Inspect cup for any possible wear, nicks, etc.

The cone assembly can be cleaned in place on the shaft. Use a standard metal cleaning solvent and a stiff bristle brush to loosen the old grease. To insure removal of the old grease and any contamination that might be present, use compressed air. Air should be directed at the cone assembly so that it goes through the bearing from one end of the rollers to the other. It is important not to "spin dry" the bearing with compressed air. Spinning the dry bearing may score the raceways and rollers due to the lack of lubricant.

Use a standard metal cleaning solvent to clean out the bearing and oil seal bore in the housing. Wipe this area clean making sure it is free from any old grease or other contamination that might be present.

After the bearing has been inspected and approved for continued service, it must be lubricated prior to installation.

The grease should be a good quality number 2 E.P. (extreme pressure), lithium soap, wheel bearing grease.

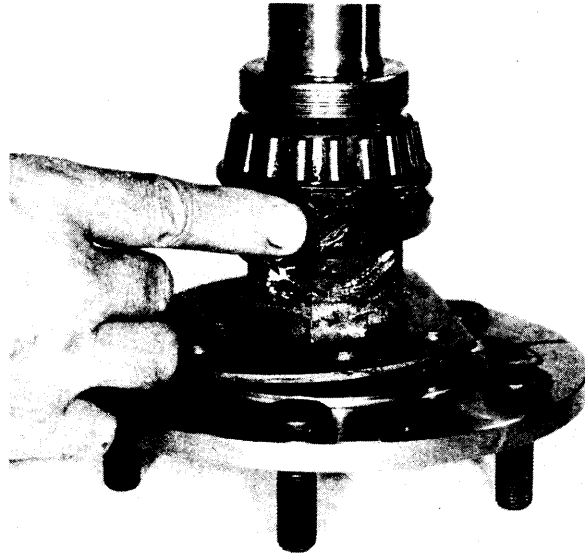

Figure 108

1009-108

Fill the area or cavity between the seal and bearing with the recommended grease.

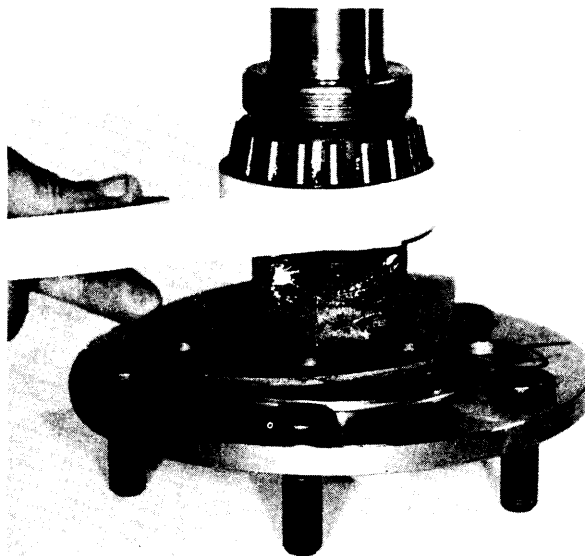

Figure 109

1009-109

Push seal and retainer away from the bearing to allow a cavity between the seal and bearing.

After the cavity is full of grease, wrap tape completely around the rib ring and seal as shown to enclose the cavity.

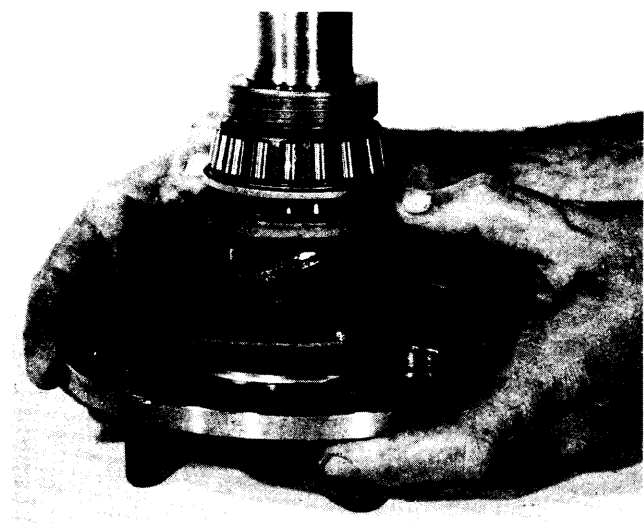

Figure 107

1009-107

# REAR AXLE

## ASSEMBLY

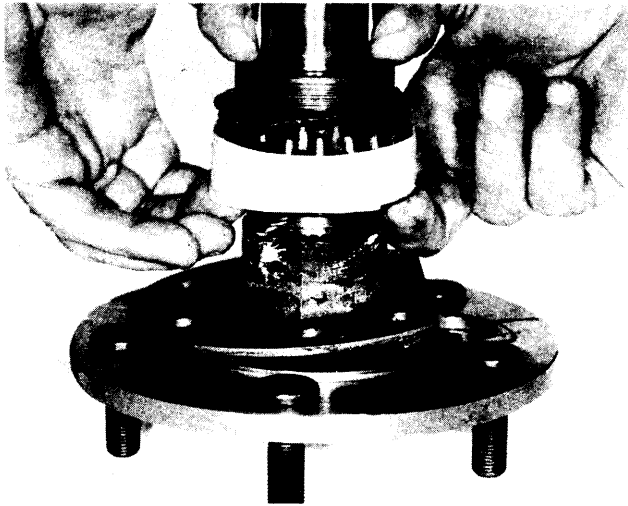

Figure 110

1009-110

With tape still wrapped around the ring, push seal up until it contacts the rib ring. This will force the grease up through the rollers.

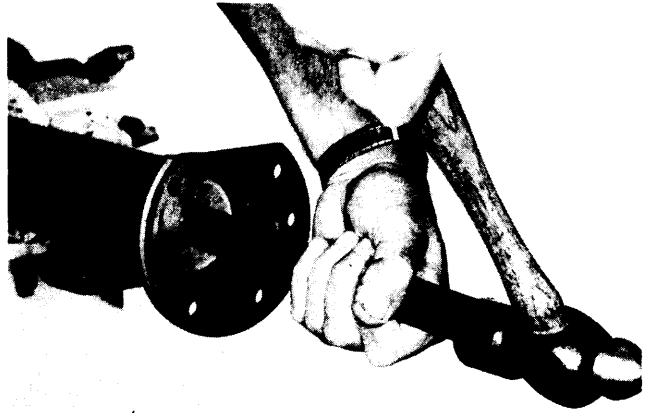

Figure 112

1009-112

Assemble new grease seal into housing.  
Tools—#D-157 Seal Installer, #C-4171 Handle.

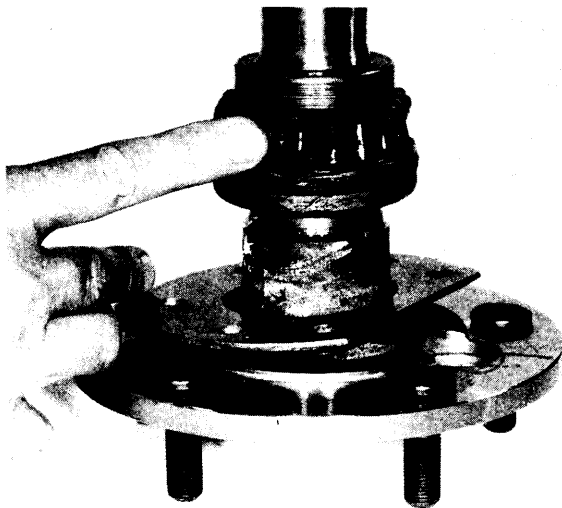

Figure 111

1009-111

### NOTE

If grease is not apparent on small end of rollers, repeat these same steps until grease appears.

Remove tape and wipe excess grease on roller bodies.

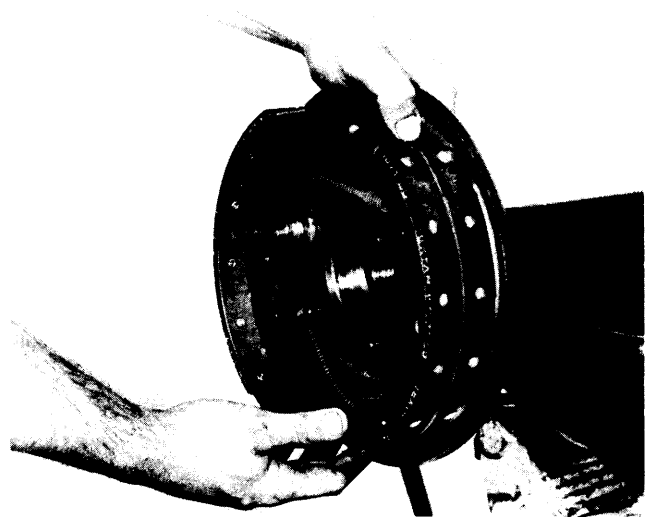

Figure 113

1009-113

After seal has been assembled, grease lip of seal.

Assemble backing plate bolts and backing plate assembly.

## REAR AXLE

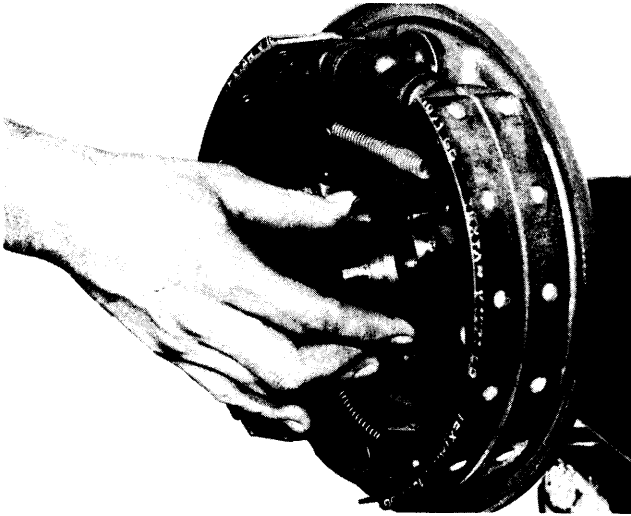

**Figure 114**

1009-114

Assemble bearing cup into bearing bore of the tube. Make sure the cup backface is against the bearing seat of the tube.

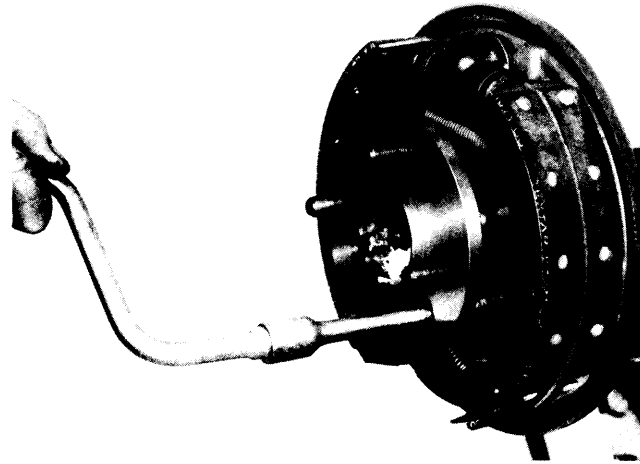

**Figure 115**

1009-115

Assemble axle shaft into housing. Care should be taken not to damage the seal lip and bearing rollers.

Line up the holes of the retainer plate with the bolts; push axle shaft into the housing as far as possible.



**Figure 116**

1009-116

Start nuts on backing plate by hand. Use a speed wrench as illustrated and tighten to approximately 15 lbs. ft.

The nuts should be tightened in a manner that assures the seal and cup rib ring are drawn evenly against the cup in the housing.



**Figure 117**

1009-117

Use a torque wrench and torque nuts to 25-35 lbs. ft.

### REMOVAL OF UNIT BEARING FROM AXLE SHAFT

#### NOTE

To disassemble axle shaft from housing, follow the procedures illustrated in Figures 1109-95 thru 1009-99.



## REAR AXLE

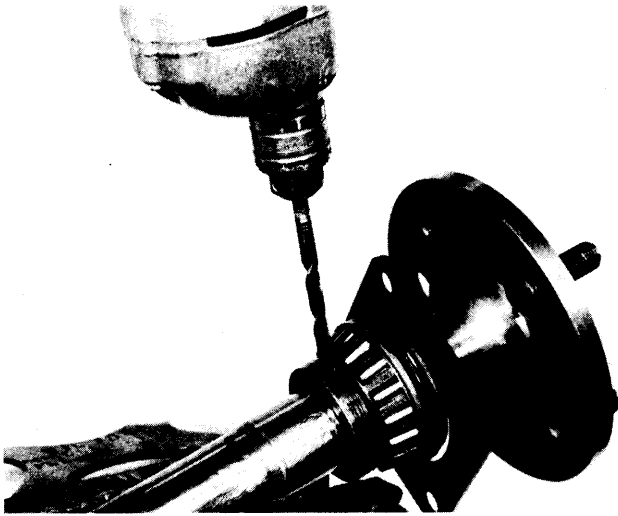

Figure 118

1009-118

Place axle shaft in a vise. Drill a  $\frac{1}{4}$ " hole in the outside of the retainer ring to a depth approximately  $\frac{3}{4}$  the thickness of the ring. Do not drill all the way through the ring; the drill could damage the axle shaft.

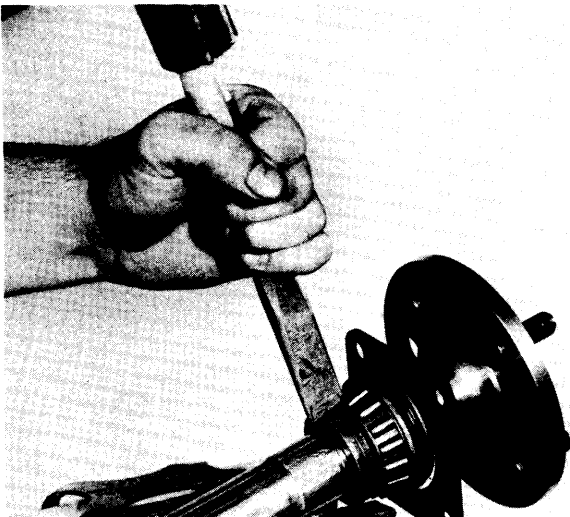

Figure 119

1009-119

After drilling the ring, use a chisel positioned across the hole and strike sharply to break the ring. Discard and replace with a new one at time of assembly.

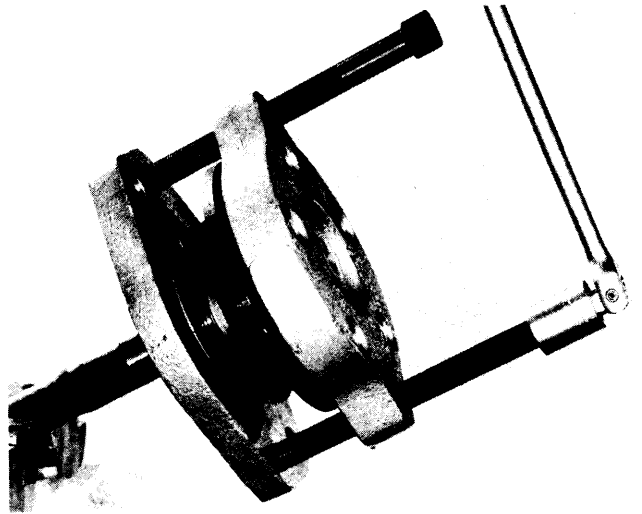

Figure 120

1009-120

Push retainer plate and seal towards flange of axle shaft. Install the flange plate to the flange of the axle shaft. Install bolts into flange plate. Slide forcing plate over the axle shaft. Install the adapters so they seat under the cup rib ring.

Gradually tighten the bolts until they locate in the dimples on the backside of the forcing plate.

Tools—#SP-5443-A Flange plate, #SP-5017 Adapter ring, #SP-5442-D Adapters, #SP-5026 Bolts.

Tighten bolts of tool alternately until bearing cone is removed from axle shaft. Be careful not to mar the machined surfaces of the axle shaft.

### CAUTION

Do not heat or cut the bearing cone assembly with a torch to remove. Damage to the axle shaft will result.

Remove seal and retainer plate. Discard seal. Replace with new one at time of assembly. Inspect retainer plate for possible distortion. If any portion of the retainer plate is damaged, it should be replaced.

Inspect machined surfaces of the axle shaft, such as the seal and bearing diameters. Clean axle shaft, remove all nicks or burrs.

### INSTALLATION OF NEW UNIT BEARING

#### NOTE

The retainer ring area of the axle shaft is 1.3790 minimum in diameter, and the retainer ring inside diameter is 1.374 maximum. Therefore, it should require some 6,000 lbs. minimum press to seat the ring against the unit bearing.

## REAR AXLE

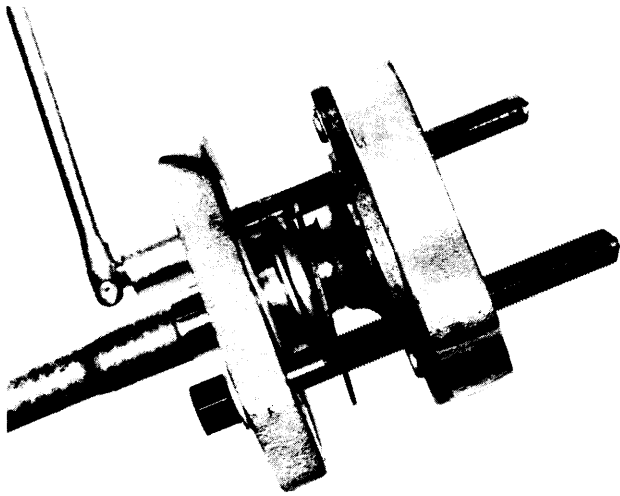

Figure 121

1009-121

Flange plate should still be assembled to the flange of the axle shaft. Remove bolts from flange plate.

Assemble new retainer plate and oil seal. The rubber portion of the oil seal, which extends beyond the casing has numbers bonded in the rubber. These numbers are to face toward the flange of the axle shaft.

Assemble new unit wheel bearing on axle shaft.

Slide installing ring on axle shaft. Be sure to locate unit wheel bearing on the inside of the installing ring. Slide forcing plate on axle shaft and locate on installing ring. Install bolts and washers through the holes in the forcing plate and into the flange plate.

Tools—#SP-5443-A Flange plate, #SP-5017 Adapter ring, #SP-5439 Adapter plate installer, #SP-5026 Bolts, #SP-3020 Washers.

Tighten bolts alternately and evenly making sure bearing is not cocked on axle shaft. Continue until unit wheel bearing is seated. To make sure bearing is seated, use a .0015" feeler gage between bearing seat and bearing. If gage enters, force bearing further on the axle shaft, until gage does not enter.

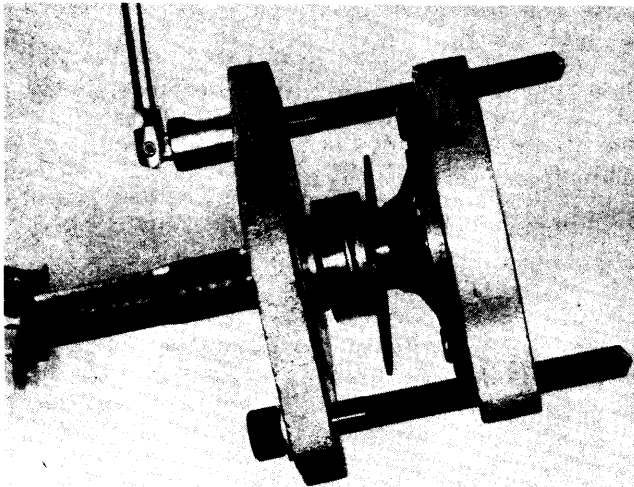

Figure 122

1009-122

Install retainer ring on axle shaft. Follow the same procedures as illustrated in Figure 1009-121 to assemble the retainer ring.

Use a .0015" feeler gage between the bearing and retainer ring to be sure that the retainer ring is seated. At least one point should exist, where the gage will not enter between the retainer ring and bearing. If gage enters completely around the diameter, retainer ring must be forced further onto the axle shaft.

To assemble axle shaft assembly into housing, follow steps as illustrated in Figures 1009-115 thru 1009-117.

### LUBRICATING NEW UNIT BEARING WITH GREASE

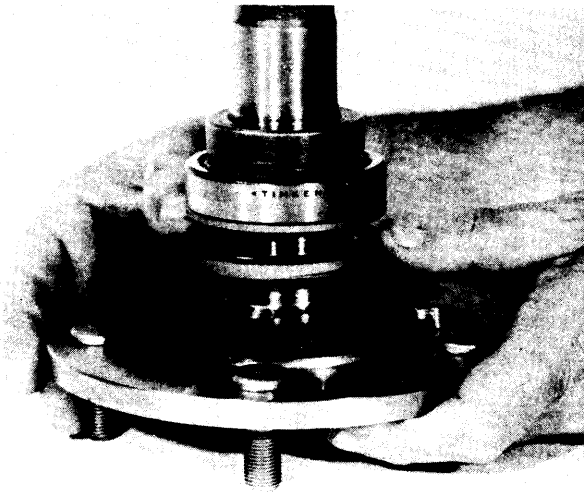

Figure 123

1009-123

Push seal and retainer away from bearing to allow a cavity between the seal and bearing.

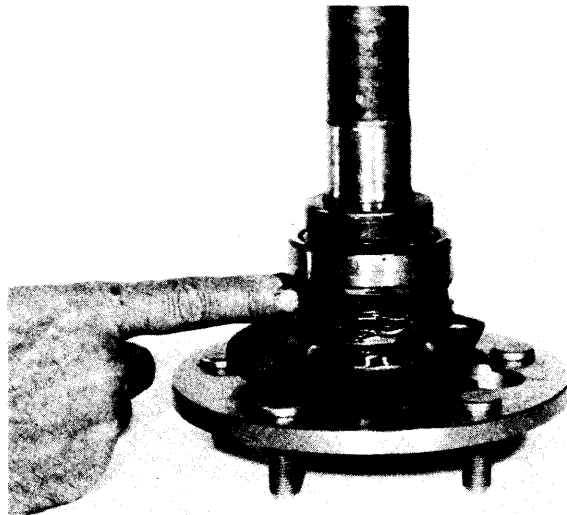

Figure 124

1009-124

Fill cavity with a good quality #2 E.P. (extreme pressure), lithium soap, wheel bearing grease.

## REAR AXLE

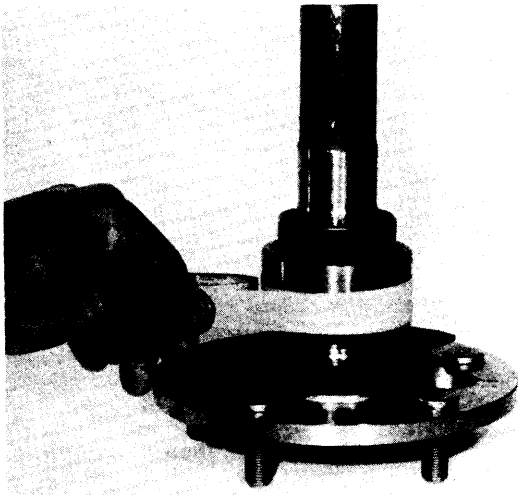

Figure 125

1009-125

After cavity is full of grease, wrap tape completely around rib ring, and seal to enclose the cavity.

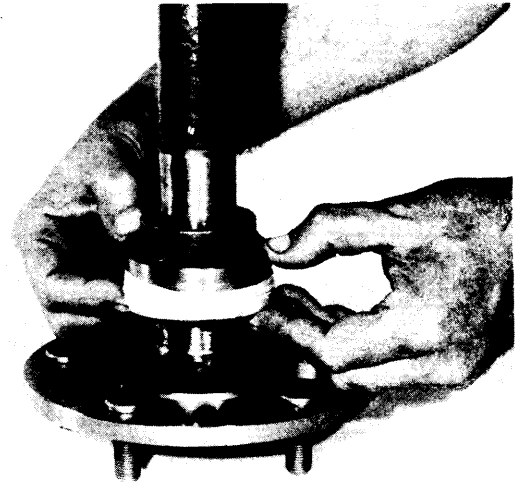

Figure 126

1009-126

Push seal towards the bearing until it contacts the rib ring. This will force the grease between the rollers and cup.

### NOTE

If grease is not apparent on the small ends of the rollers, repeat the same steps until grease is evident between the small end of the roller and cup. **Remove tape.**

## CARRIER SECTION

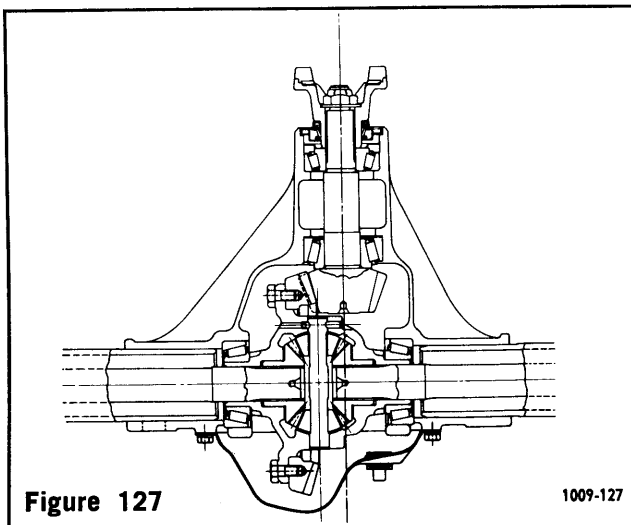

Figure 127

1009-127

L/D Carrier.

### DISASSEMBLY

#### NOTE

If it becomes necessary to disassemble any parts inside the carrier, it is suggested that the entire axle be removed from the vehicle and held tight in a stand or rack.

Remove drain plug and drain lubricant. If there is no drain plug in the carrier, the lube will drain out as the cover plate is removed.

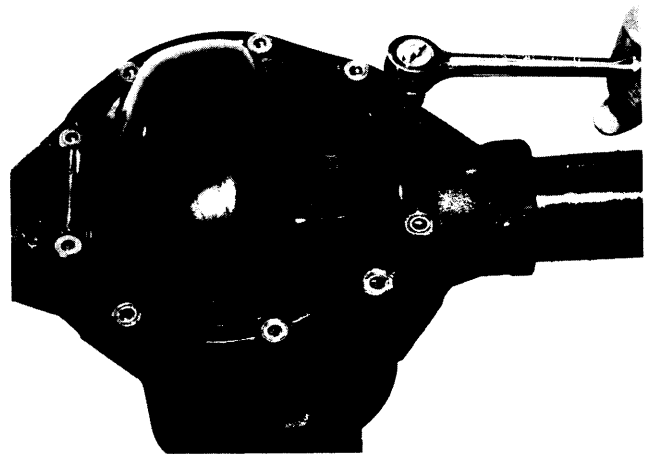

Figure 128

1009-128

Remove cover plate screws, cover plate, and cover plate gasket. **Discard old gasket.** Tip carrier to allow lube to drain completely.

Also, during this time clean the cover face of the carrier, making sure it is free from any nicks and any particles left by the old gasket.

# CARRIER SECTION

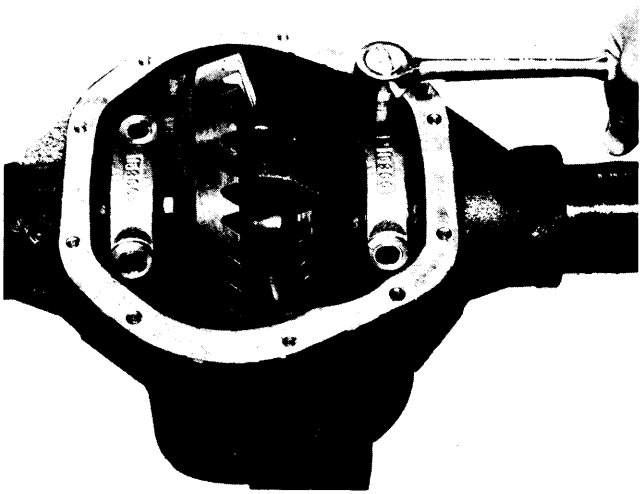

Figure 129

1009-129

Remove bearing caps. Note mating letters stamped on caps and carrier. This is important at time of assembly as they are to be assembled exactly as removed. Letters or numbers are in horizontal and vertical position.

### CAUTION

Before removing differential case and ring gear, make sure the axle shafts are pulled out far enough for clearance to remove differential.

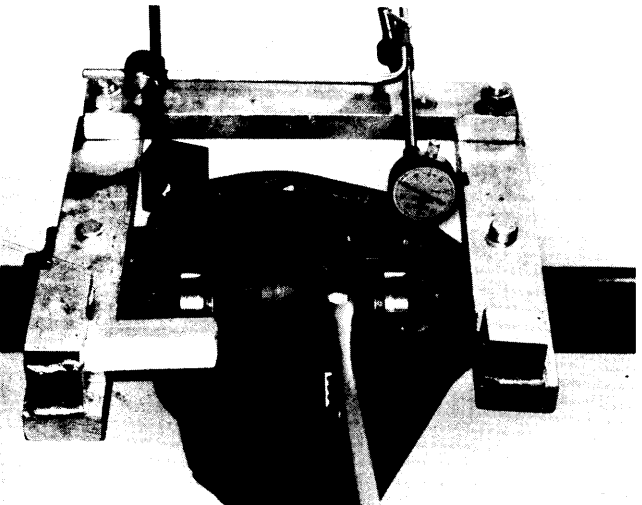

Figure 130

1009-130

Mount spreader to housing. Do not spread carrier over .020". Use dial indicator as shown. Note: This spreader can also be used on the Spicer Model 44 axle.

Tools — #D-113 Spreader, #D-128 Indicator set.

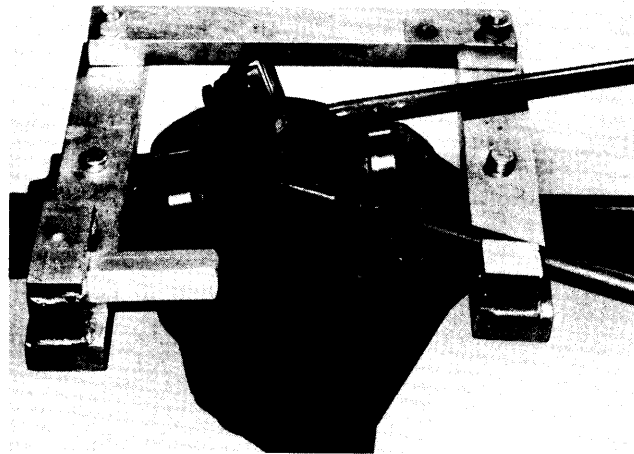

Figure 131

1009-131

Pry differential case from carrier with two pry bars as shown. After differential case has been removed, remove spreader. Use caution to avoid damage to ring and pinion. Mark on tag bearing cups indicating from which side they were removed.

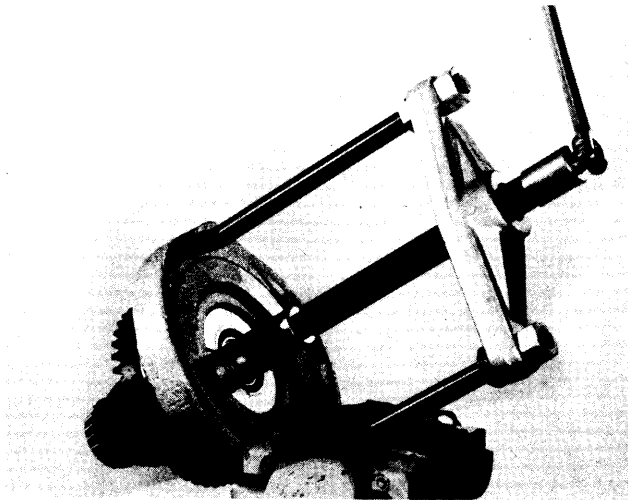

Figure 132

1009-132

Remove differential bearings with a puller as shown. Wire shims, bearing cup and bearing cone together. Identify from which side they were removed (ring gear side or opposite side). If shims are mutilated, replace with new shims at the time of assembly. Shims are available in thicknesses of .003", .005", .010", and .030". Reposition case in puller and remove other bearing cone as described above.

Tools—#DD-914-9P Press and Adapter Ring, #C-293-3 Adapter Plug, #C-293-18 Adapter Set.

### NOTE

It is recommended that whenever bearings are removed, they are (regardless of mileage) to be replaced with new ones.

# CARRIER SECTION

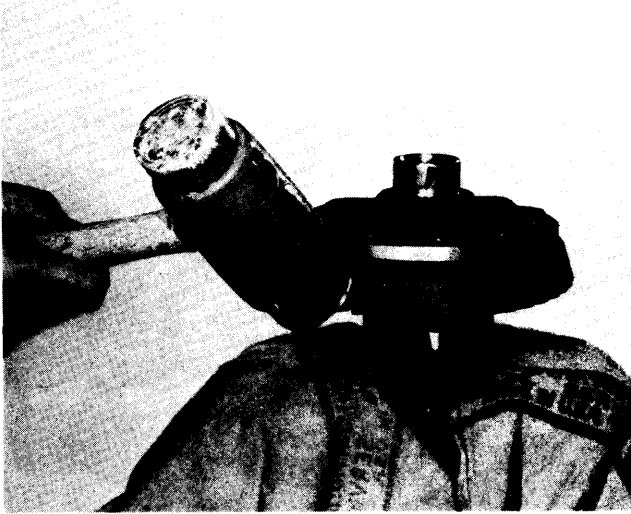

Figure 133

1009-133

Place a few shop towels over the vise to prevent the ring gear teeth from being nicked after it is free from the case.

Place case in vise. Remove ring gear screws. Tap ring gear with a rawhide hammer to free it from the case. Remove case and ring gear from vise.

## NOTE

It is recommended that whenever the ring gear screws are removed, they are to be replaced with new ones.



Figure 134

1009-134

Replace case in vise and drive out lock pin which secures the pinion mate shaft. Use a small drift as shown.

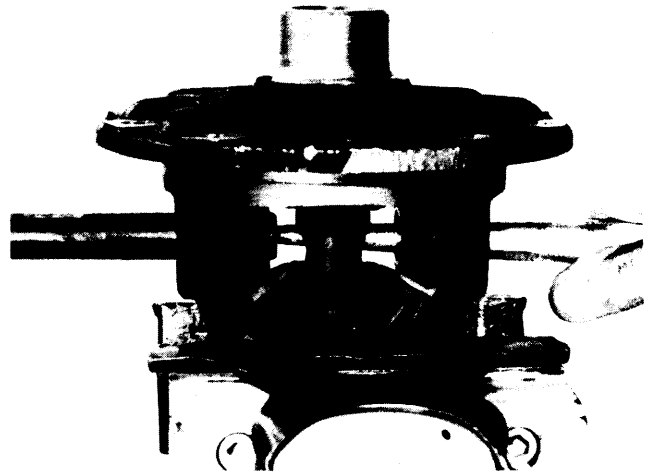

Figure 135

1009-135

Remove pinion mate shaft with drift as shown.

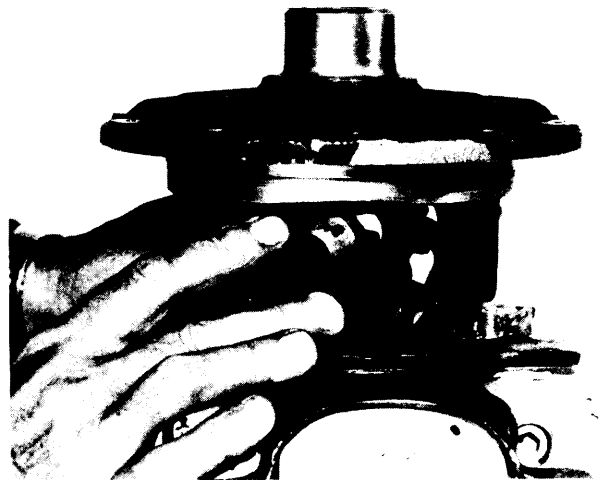

Figure 136

1009-136

To remove side gears and pinion mate gears, rotate the side gears. This will allow the pinion mate gears to turn to the opening of the case. Remove pinion mate gears and also the spherical washers behind the gears. Lift out gears and thrust washers. Inspect all parts, including the machined surfaces of the case itself. Where necessary replace all worn parts. If excessive wear is visible on all parts, it is suggested that the complete differential assembly be replaced. If any one of the gears are to be replaced, they are to be replaced as a set.

## NOTE

Axle shafts which require end play adjustment have a spacer block in the differential case. The spacer block controls the end thrust of the axle shaft. If the ends of the spacer block are worn, it is to be replaced during assembly. Spacer block must not be used with ball or unit wheel bearings.

# CARRIER SECTION

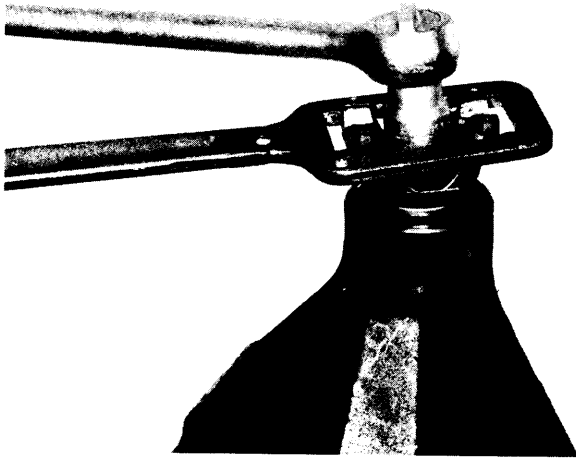

Figure 137

1009-137

Turn nose of carrier in a horizontal position to remove pinion nut. Hold end yoke or flange with tool similar to the one shown, and remove pinion nut and washer.

Tool—#C-3281 Holding wrench.



Figure 139

1009-139

Remove pinion by tapping with a rawhide hammer. Catch the pinion with your hand to prevent it from falling to the ground and being damaged.

## NOTE

On the spline end of the pinion, there are bearing preload shims. These shims may stick to the bearing — pinion — or even fall out. The shims are to be collected and kept together since they will be used later in assembly. Try not to mutilate shims. If shims are mutilated, replace with new ones; shims are available in thicknesses of .003", .005", .010", and .030".

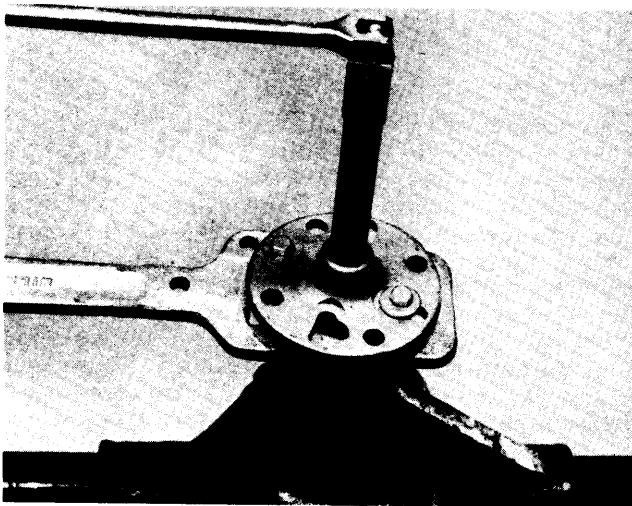

Figure 138

1009-138

Remove end yoke or flange with tools as shown. If yoke or flange shows wear in the area of the seal contact, it should be replaced.

Tool—#C-452.



Figure 140

1009-140

Pull out pinion seal with puller as shown. Discard seal. Replace with new seal at time of assembly. Remove bearing cone and outer pinion oil slinger.

Tool—#D-131 Slide hammer.

# CARRIER SECTION

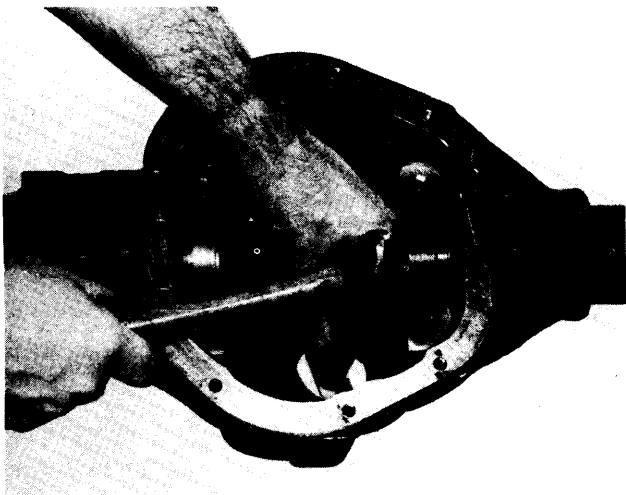

**Figure 141**

1009-141

Turn nose of carrier down. Remove outer pinion bearing cup as shown. Locate driver on back edge of cup; drive cup out of carrier. **Caution: Do not nick carrier bore.**

Tools—#D-147 Remover, #C-4171 Handle.



**Figure 143**

1009-143

Remove the inner bearing cup with tools as shown.

Tools—#D-148 Remover, #C-4171 Handle.

## NOTE

Shims are located between the bearing cup and carrier bore, and, as illustrated in Figure 142, may also include an oil baffle. If shims and baffle are bent or nicked, they should be replaced at time of assembly. Wire the stacks together and measure each. If stack has to be replaced, replace with the same thickness.



**Figure 142**

1009-142

## NOTE

The front and rear axle carrier section may vary in pinion bore depth due to the possibility of the need for either a baffle or slinger or both.

The baffle serves the same purpose of assisting the lube to flow up through the oil channels to lubricate the pinion bearings. If used, they are part of the pinion setting adjustment. In Figure 1009-142 we show the four different options.

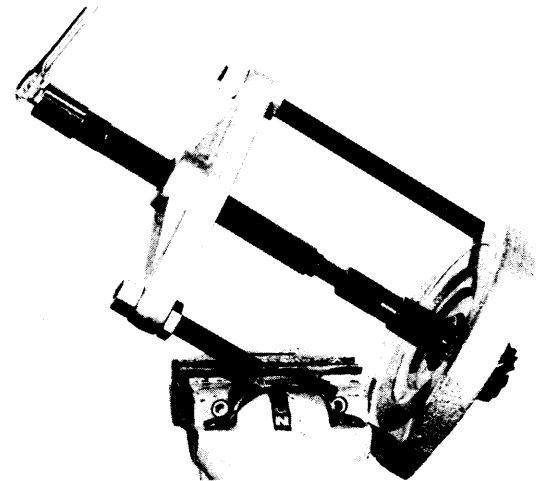

**Figure 144**

1009-144

Remove inner pinion bearing cone with tools as shown.

Tools—#DD-914-P Press, #DD-914-9 Adapter Ring, #C-293-39 Adapter Set.

## NOTE

Both baffle and slinger are part of the pinion adjustment shims and are to be kept intact for assembly.

# CARRIER SECTION

## ASSEMBLY

On all front axles there are axle shaft oil seals which are pressed into the tube ends of the carrier. There are two different designs.

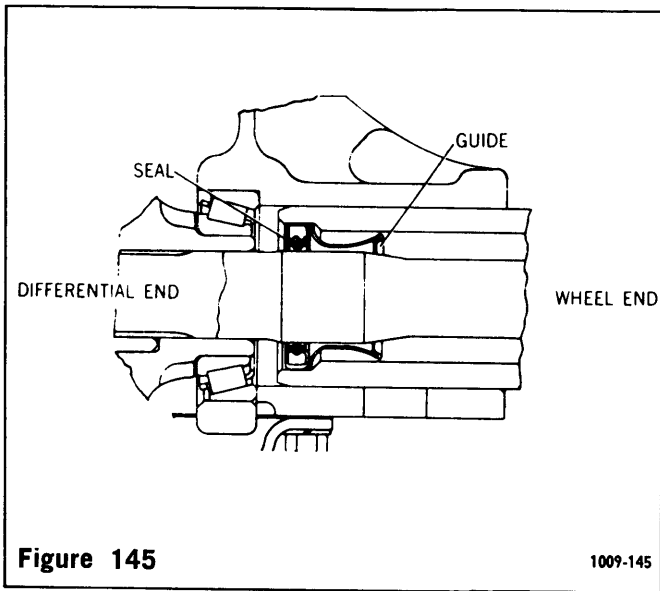

As shown in Figure 1009-145, this design consists of an axle shaft guide and seal. (One guide and one seal for each side.)

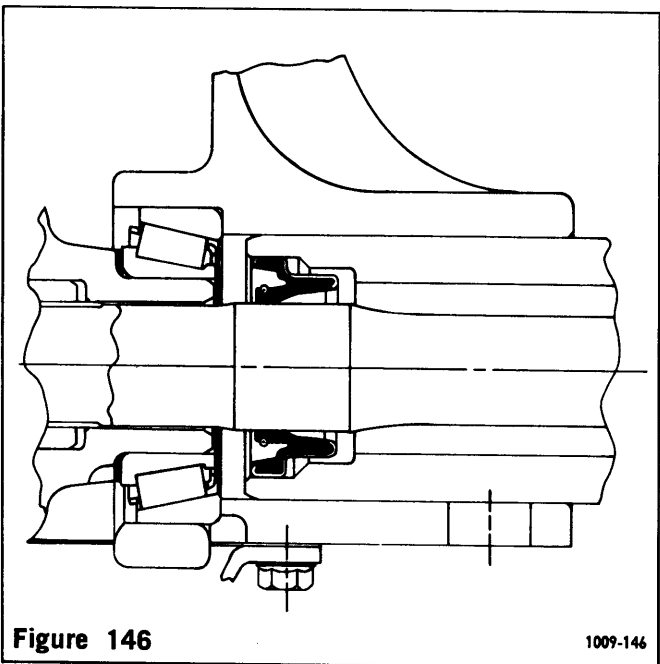

As shown in Figure 1009-146, this design consists of the integral seal (unit) whereby the seal and guide are combined. (One seal for each side.)

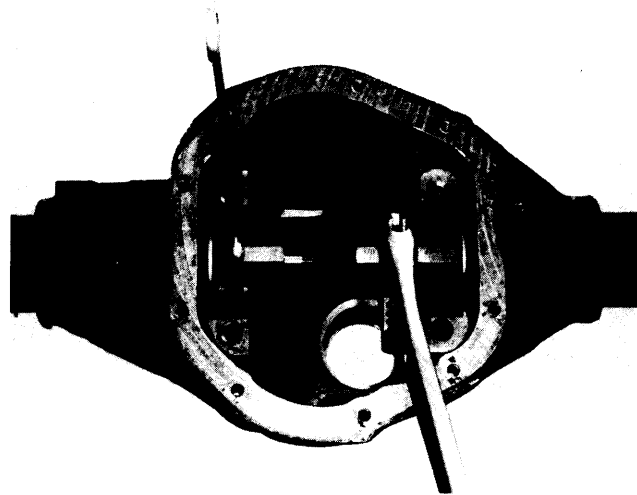

Figure 147

1009-147

Assemble inner axle shaft seals and guides. To assemble axle shaft guides and seals, use tools as described.

Tools—#D-112 Screw, #D-112-1 Adapter.

When assembling the seals make sure they are positioned straight and do not get cocked.

Turn forcing screw until it stops; seal will then be seated.

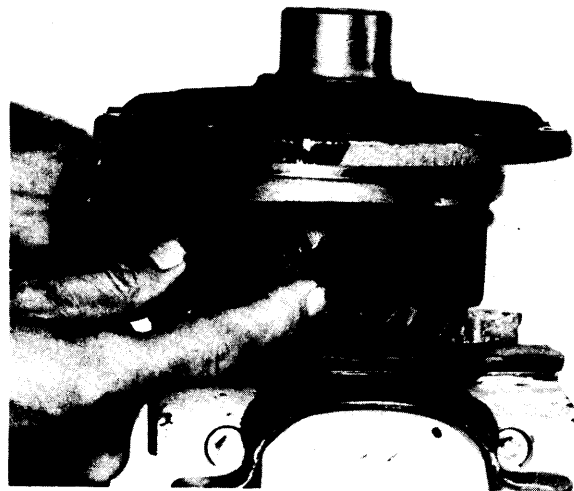

Figure 148

1009-148

Place differential case in vise as shown. Apply grease to new side gear thrust washers and hubs of side gear. Assemble both side gears. Apply grease to new pinion mate spherical washers and the pinion mate gears. Assemble pinion mate gears. An easy way to assemble the side gears and pinion mate gears is to have all parts lubricated before assembly. Assemble both side gears and thrust washers, hold them in place with hand, then assemble the pinion gears to hold the side gears in place.

Rotate the side gears until the holes of the washers and pinion gears line up with the holes of the case. If the gears cannot be rotated by hand, install one of the axle shafts into the side gear spline and use a pipe wrench to turn the shafts.



# CARRIER SECTION

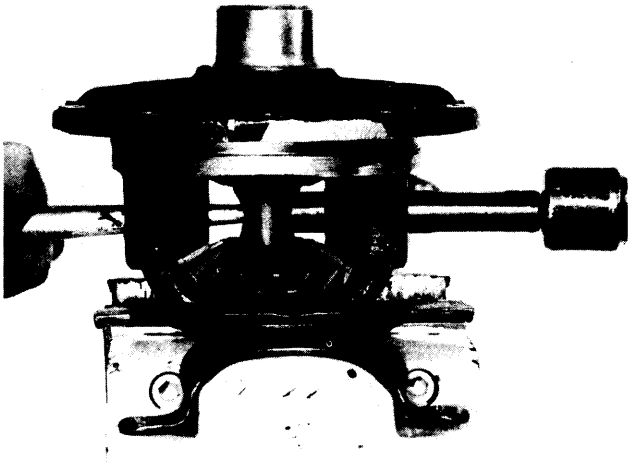

Figure 149

1009-149

If spacer block is used, assemble as shown. Use a drift to line holes of the gears up with the case. Assemble shaft, drive on shaft to remove drift. Be sure vertical lock pin hole is lined up with that of the case, and that the pinion mate spherical washers are in place and lined up with gear and case.

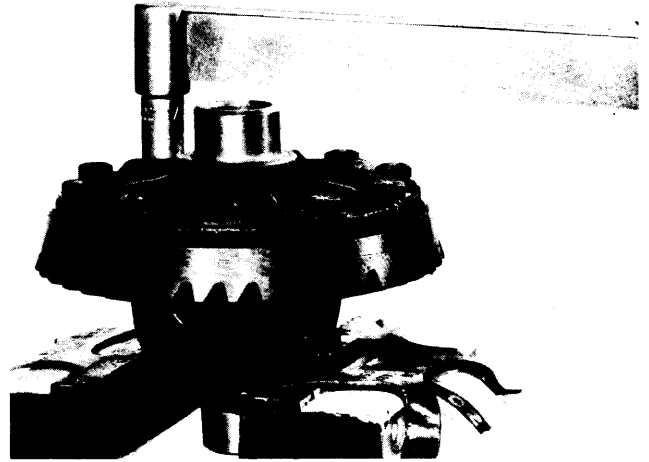

Figure 151

1009-151

Be sure flange face of the case is free of nicks or burrs. Assemble ring gear to case **using new ring gear screws**. Line up holes of gear and case. Draw up screws alternately and evenly.

Torque screws to 45-60 lbs. ft.

Tool—#C-524-A Torque wrench.



Figure 150

1009-150

Assemble lock pin. Peen metal of case over pin to lock in place.



Figure 152

1009-152

Install master differential bearing onto case. Remove all nicks, burrs, dirt, etc., from hubs to allow master bearings to rotate freely.

Tool—#D-135 Master bearings.

# CARRIER SECTION



Figure 153

1009-153

Assemble differential case into carrier (less pinion). Mount dial indicator with a magnetic base as shown. Locate tip of indicator on flat surface of one of the gear screws. Mark screw with a piece of chalk. Force the differential assembly as far as possible in the direction towards the indicator. With force still applied, set indicator at zero (0).

Tool—#D-128 Indicator.

### NOTE

Indicator should have a minimum of .200" travel.



Figure 154

1009-154

Force the differential assembly as far as it will go in the opposite direction. Repeat these steps until the same reading is obtained.

Record the reading of the indicator.

This will be the total amount of shims required (less preload) and will be calculated later during assembly.

After making sure the readings are correct, remove indicator and differential assembly from housing. Do not remove master bearings from differential case at this time.



Figure 155

1009-155

View of ring and pinion set.

Ring gears and pinions are supplied in matched sets only. Matching numbers on both the pinion and ring gear are etched for verification. If a new gear set is being used, verify the numbers of each pinion and ring before proceeding with assembly.

The distance from the centerline of the ring gear to the button end of the pinion for the Model 44 (Front and Rear) axle is 2.625 inches.

On the button end of each pinion there is etched a plus (+) number, a minus (-) number, or a zero (0) number, which indicates the best running position for each particular gear set. This dimension is controlled by the shimming behind the inner bearing cup.

For example — if a pinion is etched +3, this pinion would require .003" less shims than a pinion etched "0". This means by removing shims, the mounting distance of the pinion is increased to 2.268" which is just what a +3 indicates. Our if a pinion is etched -3, we would want to add .003" more shims than would be required if the pinion were etched "0". By adding .003" shims the mounting distance of the pinion was decreased to 2.622" which is just what a -3 etching indicated.

If the old ring and pinion set is to be reused, measure the old shim pack and build a new shim pack to this same dimension. If a baffle is in the axle assembly, it is considered as part of the shim pack.

To change the pinion adjustment, shims are available in thicknesses of .003", .005", and .010".

### NOTE

If baffle or slinger is bent or mutilated, it should be replaced.

Measure each shim separately with a micrometer and add together to get total shim pack thickness from original build up.

If a new gear set is being used, notice the (+) or (-) etching on both the old and new pinion and

# CARRIER SECTION

adjust the thickness of the new shim pack to compensate for the difference of these two figures.

For example: If the old pinion reads (+) 2 and the new pinion is (-) 2, add .004" shims to the original shim pack.

The above procedures also apply to pinion adjustment on the front axle which includes the oil slinger between the inner bearing cone and pinion, and baffle between the inner bearing cup and carrier.

## CARRIER SECTION

Old Pinion Marking	New Pinion Marking								
	-4	-3	-2	-1	0	+1	+2	+3	+4
+4	+0.008	+0.007	+0.006	+0.005	+0.004	+0.003	+0.002	+0.001	0
+3	+0.007	+0.006	+0.005	+0.004	+0.003	+0.002	+0.001	0	-0.001
+2	+0.006	+0.005	+0.004	+0.003	+0.002	+0.001	0	-0.001	-0.002
+1	+0.005	+0.004	+0.003	+0.002	+0.001	0	-0.001	-0.002	-0.003
0	+0.004	+0.003	+0.002	+0.001	0	-0.001	-0.002	-0.003	-0.004
-1	+0.003	+0.002	+0.001	0	-0.001	-0.002	-0.003	-0.004	-0.005
-2	+0.002	+0.001	0	-0.001	-0.002	-0.003	-0.004	-0.005	-0.006
-3	+0.001	0	-0.001	-0.002	-0.003	-0.004	-0.005	-0.006	-0.007
-4	0	-0.001	-0.002	-0.003	-0.004	-0.005	-0.006	-0.007	-0.008

Figure 156

1009-156

Pinion setting chart shown. Use this chart as a guideline to set pinion.

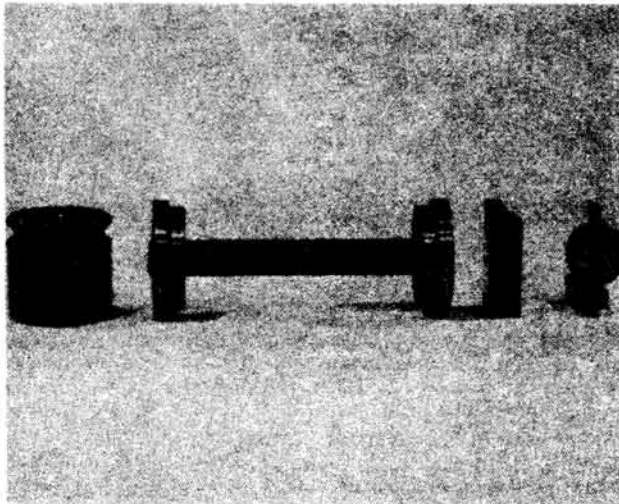

Figure 157

1009-157

View of master pinion block, pinion height block, scooter gage, cross arbor, and master bearing discs.

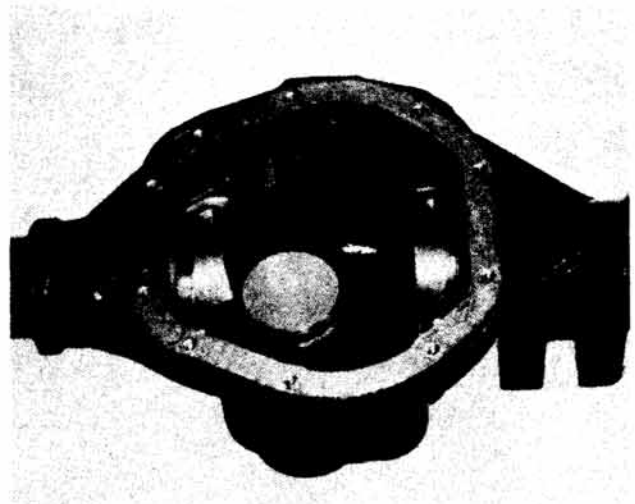

Figure 158

1009-158

Place the master pinion block into the pinion bore of the carrier as shown.

Tool—#D-139 Master pinion block.

### NOTE

Cross arbor and master bearing discs can be used on both the Model 30 and Model 44 axles. Use large diameter discs for Model 44 axle.

Be sure that all carrier bores are free from all nicks, dirt or any other contamination.

# CARRIER SECTION

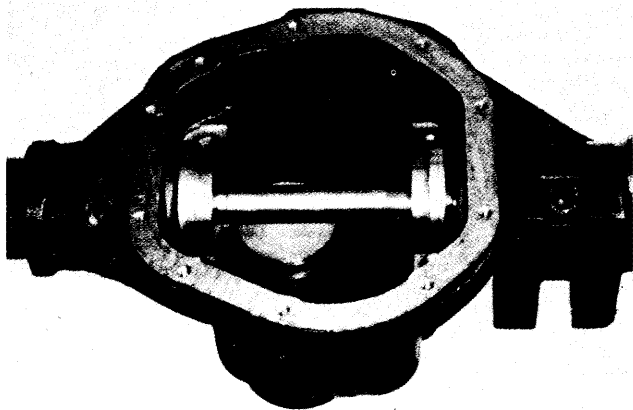
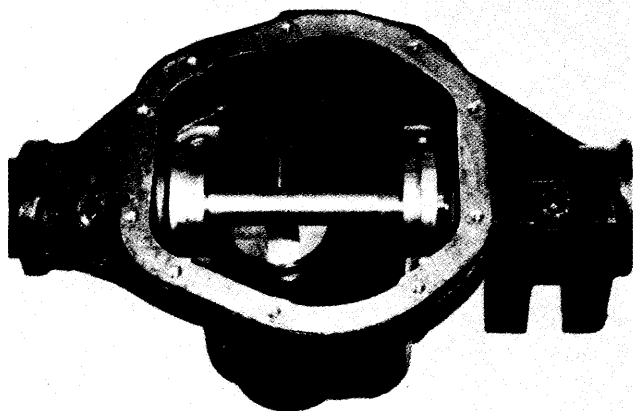

**Figure 159**

1009-159

Place arbor discs and arbor into cross bores of the carrier as shown.

Tools—#D-115-3 Arbor, #D-115-4 Arbor discs.

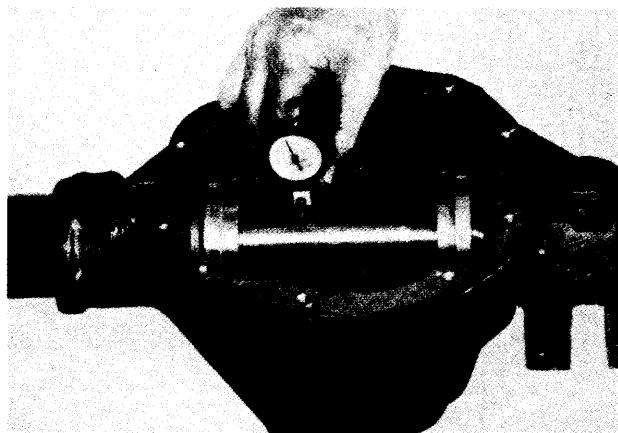

**Figure 160**

1009-160

Place pinion height block on top of master pinion block, and against arbor as shown.

Tool—#D-115-1 Pinion height block.

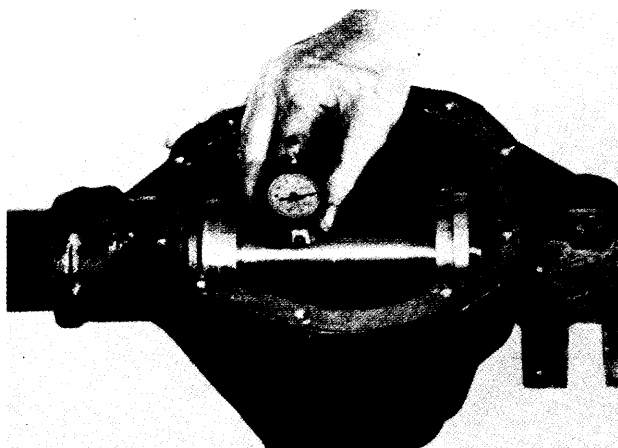

**Figure 161**

1009-161

Place scooter gage on small step of pinion height block. Apply pressure with fingers making sure the gage is flat on the pinion height block, while pressure is applied, set indicator at zero "0".

Tool—#D-115 Scooter gage.



**Figure 162**

1009-162

Slide scooter gage over arbor. As gage slides over top of arbor, it will travel in a clockwise direction. When indicator is on center of arbor (on top), it will stop traveling in a clockwise direction. If indicator starts to travel in a counterclockwise direction, this means that you have passed the center (top) of the arbor. Record only the reading when the indicator is at the highest point. This reading indicates the amount of shims necessary to obtain the correct shim pack, plus (+) or minus (—) the etching on the bottom end of the pinion. If the etching is zero (0), the shim pack will remain unchanged.

For example: If a pinion is etched +3, this pinion would require .003" less shims than a pinion etched zero "0".

If a pinion is etched —3, we would want to add .003" more shims than would be required if the pinion were etched zero "0".

## CARRIER SECTION

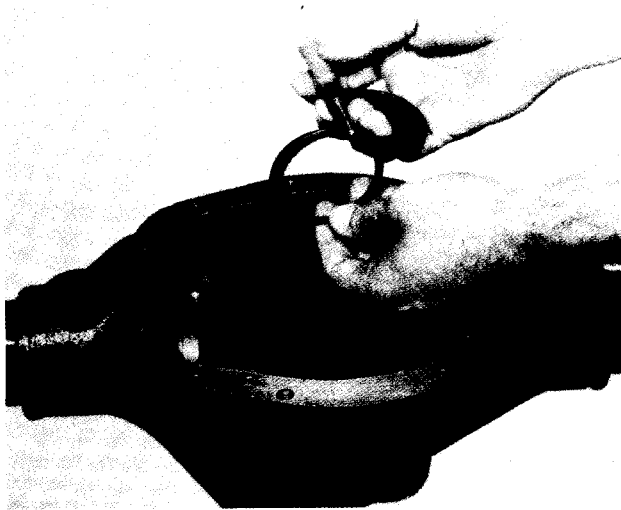

**Figure 163**

1009-163

Measure each shim separately with a micrometer and add together to get total shim pack thickness. If baffle is required, it is to be included in the shim pack. If slinger is used between the inner bearing cone and thrust face of pinion, the slinger is also to be measured and included as a part of the total shim pack.

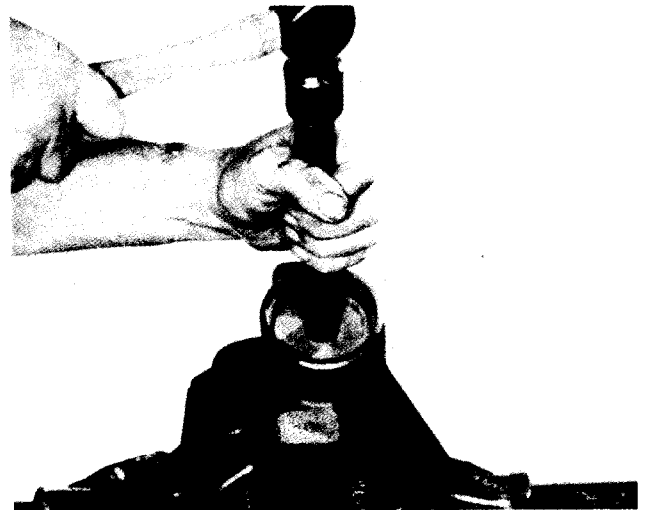
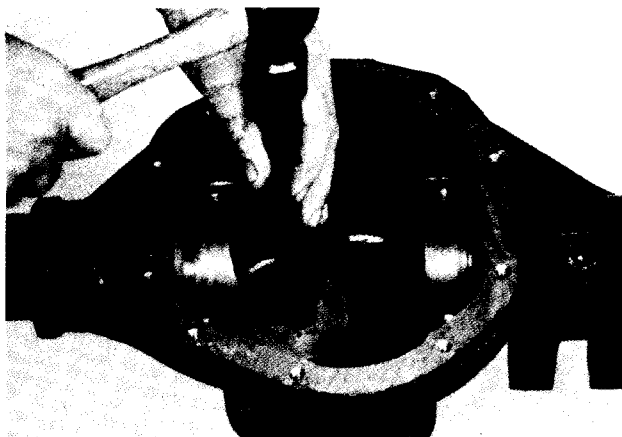

**Figure 165**

1009-165

Assemble the outer pinion bearing cup into carrier as shown.

Tools—#D-144 Cup installer, #C-4171 Handle.

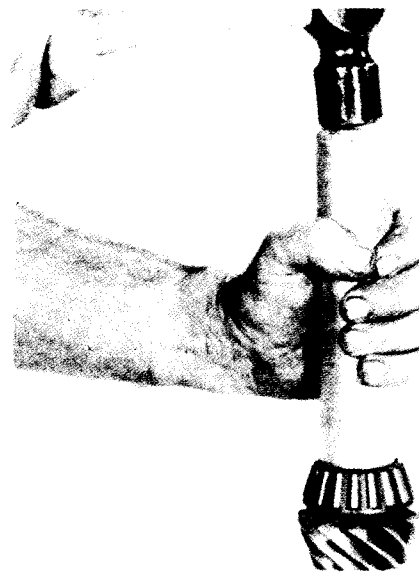

**Figure 164**

1009-164

Place the required amount of shims (and baffle if used) in the inner bearing bore; drive the inner bearing cup into carrier with tools as shown.

Tools—#D-145 Cup installer, #C-4171 Handle.



**Figure 166**

1009-166

Assemble inner bearing cone (and slinger if used) on pinion, place bearing installer over pinion shaft as shown. Drive bearing on shaft until it is completely seated.

Tool—#W-262.

# CARRIER SECTION

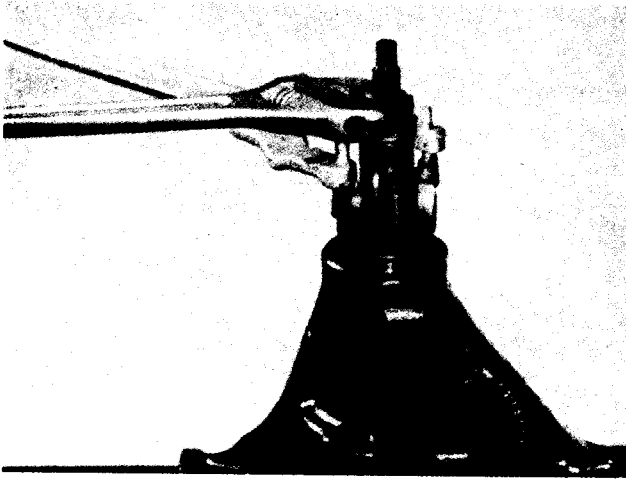

Figure 167

1009-167

Install pinion into carrier.  
Assemble outer pinion bearing cone, (slinger if used) and end yoke onto pinion spline.

### NOTE

Do not assemble preload shims or pinion oil seal at this time.

Use yoke installer (as shown) to assemble end yoke onto spline of pinion.

Tools—#W-162 Installer, #C-3281 Holder.

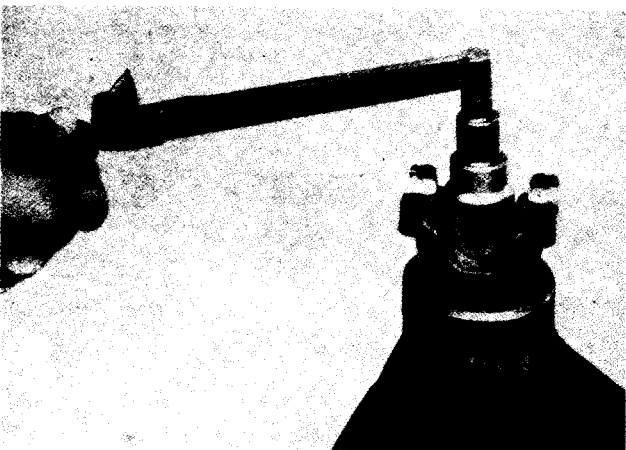

Figure 168

1009-168

Assemble washer and pinion nut. Torque nut until it requires 10 lbs. inch to rotate pinion. Rotate pinion several times before checking pinion position. This is to seat the bearings and assure a more accurate reading of pinion depth setting.

Tool—#C-685-A Inch lb. torque wrench.

### NOTE

The reason for not assembling preload shims and new pinion oil seal at this time is due to the possibility of having to adjust pinion preload or pinion adjustment. It would be necessary to again remove the seal, and as mentioned, whenever seals are removed they are to be discarded because of possible damage.

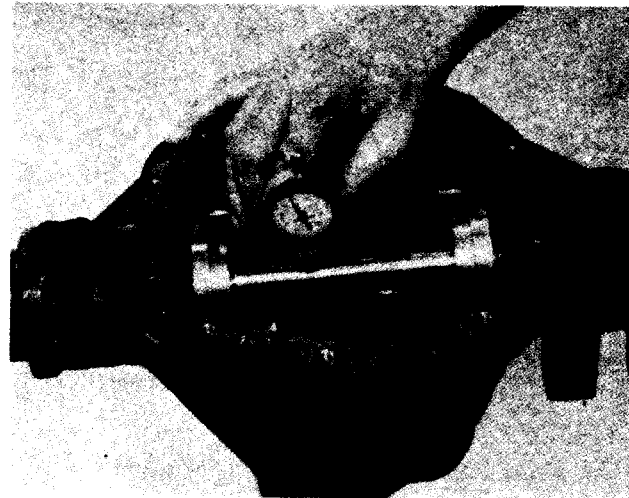

Figure 169

1009-169

Place arbor and arbor discs (small diameter discs for Model 30 axle) into cross bore of carrier. Place pinion height block on button end of pinion. Set dial indicator on zero "0".

Slide scooter gage across or over arbor.

Indicator will read a plus (+) or minus (—) at its highest point, depending on the etching of the pinion.

### NOTE

Indicator reading within .002 of etching is considered acceptable.

If pinion positioned is found to be within specifications continue with build up. If pinion position is not within specifications, change shim pack thickness under inner bearing cup.

Remove pinion nut, washer, end yoke, slinger, and bearing cone. Assemble preload shims (which were removed during disassembly) onto pinion. Assemble bearing cone, slinger.



Figure 170

1009-170

Apply a light coat of hypoid lubricant to the lip of the pinion seal and assemble into housing.

Tools—#W-147D Seal installer, #C-4171 Handle.

# CARRIER SECTION

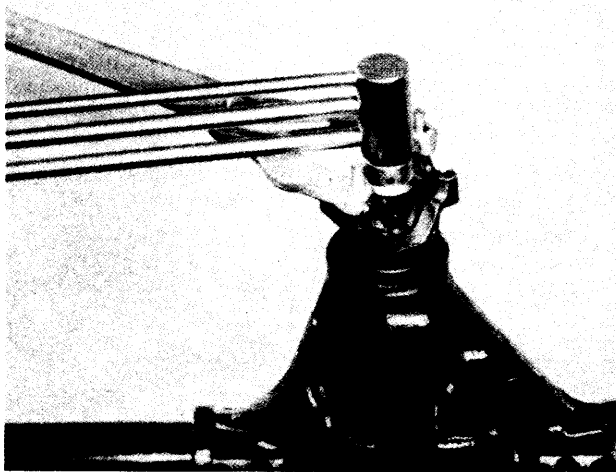

Figure 171

1009-171

Assemble end yoke, washer, and pinion nut. Torque nut to 200-220 lbs. ft.

Tools—#C-4053 Torque wrench, #C-3281 Yoke holder.

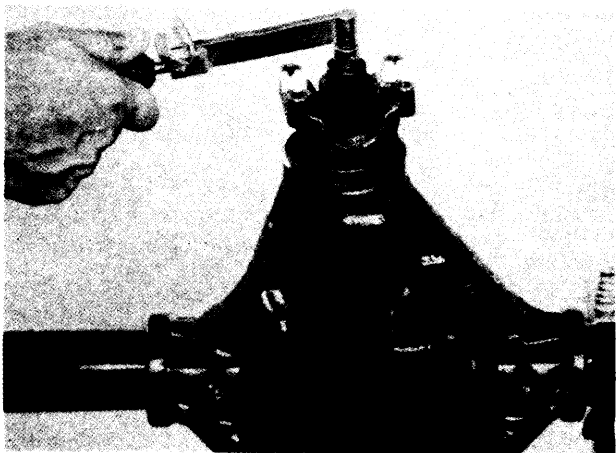

Figure 172

1009-172

Using an inch lb. torque wrench as shown, rotate pinion. Torque of pinion should read between 20-40 lbs. inch.

To increase preload, remove shims; to decrease preload, add shims.

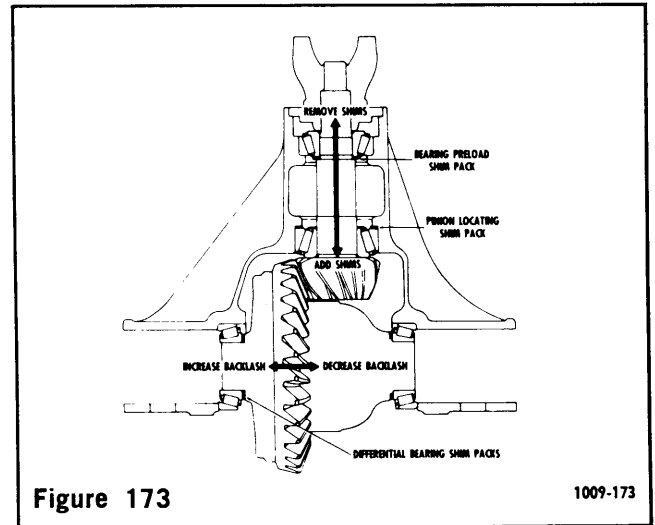

Figure 173

1009-173

L/D Carrier Section.

## CARRIER SECTION

The illustration in Figure 1009-173 shows the arrow in the pinion pointing in two directions. The direction of the arrow pointing towards the end yoke indicates that by removing pinion locating shims, the distance from the center line of the axle to pinion button is increased giving a plus reading. The preload shim pack do not affect the pinion depth setting.

Arrows on the ring gear illustrate the method to increase or decrease backlash and differential bearing preload.

## ASSEMBLY OF DIFFERENTIAL

Place differential assembly (with pinion assembled) into housing. Differential master bearings should still be installed to differential case.

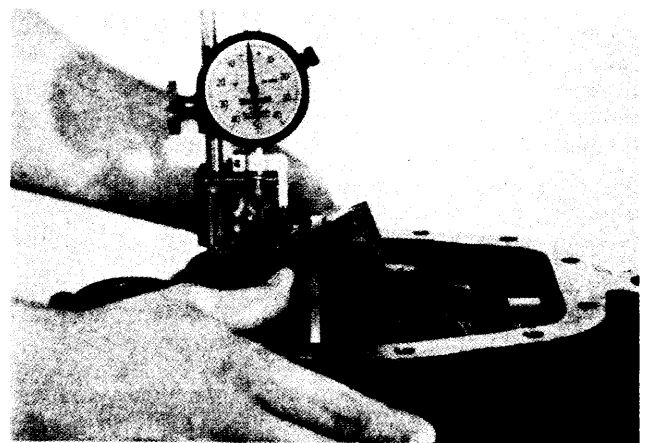

Figure 174

1009-174

Set up dial indicator as shown. Be sure to locate dial indicator on same ring gear screw as shown in Figure 1009-1. Force ring gear to mesh with pinion gear. Rock ring gear to allow the teeth of the gears to mesh. With force still applied to the differential case, set indicator at zero "0".

Tool—#D-128 Indicator.

# CARRIER SECTION

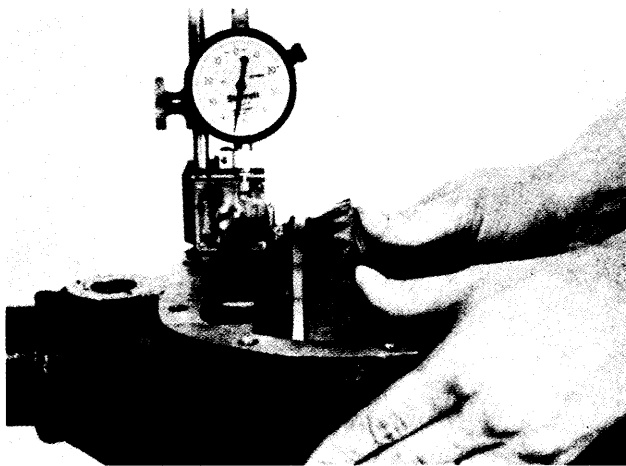

Figure 175

1009-175

Force the differential assembly (ring gear) away from the pinion gear to obtain an indicator reading. Repeat until the same reading is obtained each time. This reading will be the necessary amount of shims between the differential case and differential bearing on the ring gear side. Remove indicator and differential case from the carrier.

Remove master bearings from differential case.

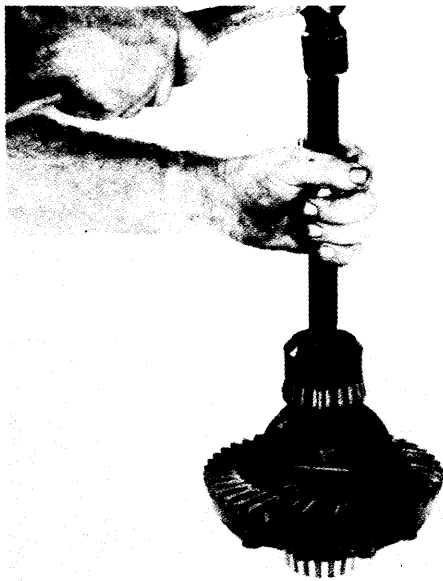

Figure 176

1009-176

Assemble the required amount of shims onto hub (ring gear side) as determined in Figure 1009-175. Place bearing cone on hub of case. Use bearing installer to seat bearing cone as shown.

Tools—#D-156 Installer, #S-4171 Handle.

Assemble the remaining of the total shim pack which was determined in Figure 1009-154 on the opposite side of the differential case. Add an additional .015 of shims on this side to compensate for differential bearing preload. Assemble differ-

ential bearing using the same tools as shown in Figure 1009-176.

For example:

In Figure 1009-154 (less pinion) a total of .085 indicator reading was recorded.

In Figure 1009-175 (with pinion) a total of .055 indicator reading was recorded. This leaves a balance .030 of shims for the opposite side and adds up to the .085 which was first recorded.

Add an additional .015 shims on the opposite side for bearing preload and backlash.

Ring gear side—.055

Opposite side—.030

Opposite side preload—.015

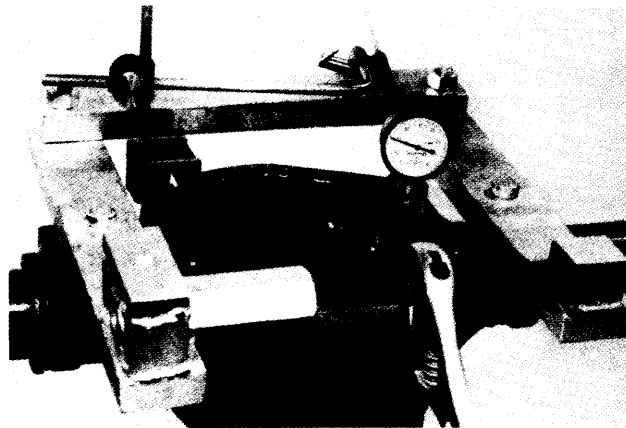

Figure 177

1009-177

Install spreader and indicator to carrier as shown.

Do not spread carrier over .015".

Remove indicator.



Figure 178

1009-178

Assemble differential bearing cups to differential bearing cones.

Install differential assembly into carrier.

Use a rawhide hammer to seat differential assembly into cross bore of carrier. Care should be taken to avoid nicking the teeth of the ring gear and pinion during assembly.



## CARRIER SECTION

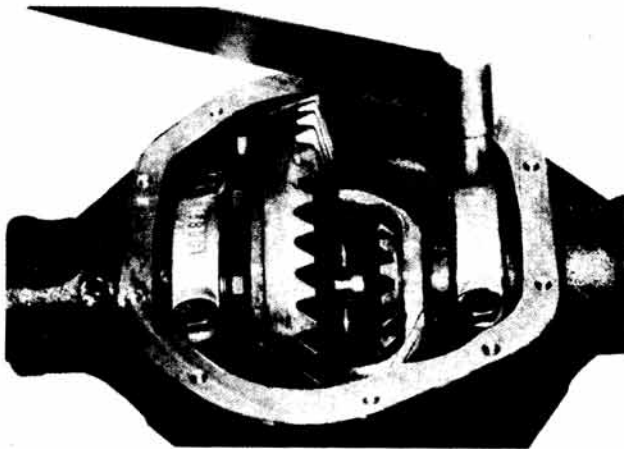

**Figure 179**

1009-179

Install bearing caps. Make sure the letters stamped on the caps correspond with those on the carrier; torque bearing cap screws to 70-90 lbs. ft.  
Tool—#C-524-A Torque wrench.

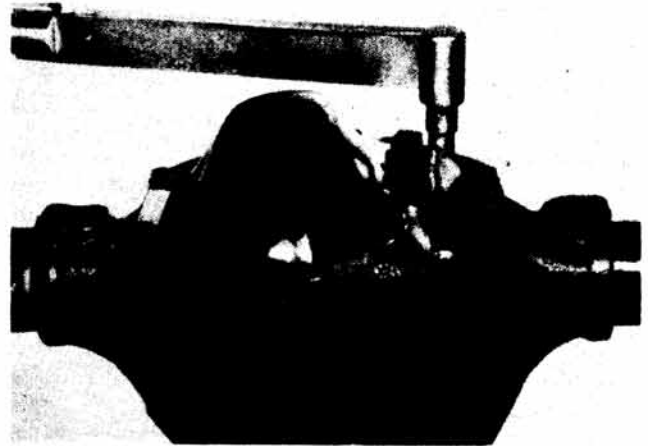

**Figure 181**

1009-181

Install new cover gasket and install cover plate. Torque screws to 30-40 lbs. ft.  
Tool—#C-524-A Torque wrench.



**Figure 180**

1009-180

Check ring gear and pinion backlash in three equally spaced points with dial indicator as shown.

Backlash tolerance is .005 to .008 and cannot vary more than .002 between points checked.

High backlash is corrected by moving the ring gear closer to the pinion.

Low backlash is corrected by moving the ring gear away from the pinion.

These corrections are made by switching shims from one side of the differential case to the other.

**WE SUPPORT  
VOLUNTARY MECHANIC  
CERTIFICATION  
THROUGH**



Dana Corporation, Spicer Axle Division, reserves the right to make changes from time to time, without notice or obligation, in specifications, descriptions, and illustrations, and to discontinue models or revise designs.

Questions regarding this manual should be directed to:

Spicer Axle Division  
Dana Corporation  
P.O. Box 1209  
Fort Wayne, Indiana 46801  
Attention: Engineering Technical Service Dept.